

ONKYO

Integrated Amplifier
A-9000R

Instruction Manual



WARNING:

TO REDUCE THE RISK OF FIRE OR ELECTRIC SHOCK, DO NOT EXPOSE THIS APPARATUS TO RAIN OR MOISTURE.

CAUTION:

TO REDUCE THE RISK OF ELECTRIC SHOCK, DO NOT REMOVE COVER (OR BACK). NO USER-SERVICEABLE PARTS INSIDE. REFER SERVICING TO QUALIFIED SERVICE PERSONNEL.



WARNING
RISK OF ELECTRIC SHOCK
DO NOT OPEN

AVIS
RISQUE DE CHOC ELECTRIQUE
NE PAS OUVRIR



The lightning flash with arrowhead symbol, within an equilateral triangle, is intended to alert the user to the presence of uninsulated "dangerous voltage" within the product's enclosure that may be of sufficient magnitude to constitute a risk of electric shock to persons.



The exclamation point within an equilateral triangle is intended to alert the user to the presence of important operating and maintenance (servicing) instructions in the literature accompanying the appliance.



Important Safety Instructions

1. Read these instructions.
2. Keep these instructions.
3. Heed all warnings.
4. Follow all instructions.
5. Do not use this apparatus near water.
6. Clean only with dry cloth.
7. Do not block any ventilation openings. Install in accordance with the manufacturer's instructions.
8. Do not install near any heat sources such as radiators, heat registers, stoves, or other apparatus (including amplifiers) that produce heat.
9. Do not defeat the safety purpose of the polarized or grounding-type plug. A polarized plug has two blades with one wider than the other. A grounding type plug has two blades and a third grounding prong. The wide blade or the third prong are provided for your safety. If the provided plug does not fit into your outlet, consult an electrician for replacement of the obsolete outlet.
10. Protect the power cord from being walked on or pinched particularly at plugs, convenience receptacles, and the point where they exit from the apparatus.
11. Only use attachments/accessories specified by the manufacturer.

12. Use only with the cart, stand, tripod, bracket, or table specified by the manufacturer, or sold with the apparatus. When a cart is used, use caution when moving the cart/apparatus combination to avoid injury from tip-over.

PORTABLE CART WARNING



13. Unplug this apparatus during lightning storms or when unused for long periods of time.
14. Refer all servicing to qualified service personnel. Servicing is required when the apparatus has been damaged in any way, such as power-supply cord or plug is damaged, liquid has been spilled or objects have fallen into the apparatus, the apparatus has been exposed to rain or moisture, does not operate normally, or has been dropped.
15. Damage Requiring Service
Unplug the apparatus from the wall outlet and refer servicing to qualified service personnel under the following conditions:
 - A. When the power-supply cord or plug is damaged,
 - B. If liquid has been spilled, or objects have fallen into the apparatus,
 - C. If the apparatus has been exposed to rain or water,
 - D. If the apparatus does not operate normally by following the operating instructions. Adjust only those controls that are covered by the operating instructions as an improper adjustment of other controls may result in damage and will often

- E. If the apparatus has been dropped or damaged in any way, and
 - F. When the apparatus exhibits a distinct change in performance this indicates a need for service.
16. Object and Liquid Entry
Never push objects of any kind into the apparatus through openings as they may touch dangerous voltage points or short-out parts that could result in a fire or electric shock.
The apparatus shall not be exposed to dripping or splashing and no objects filled with liquids, such as vases shall be placed on the apparatus.
Don't put candles or other burning objects on top of this unit.
17. Batteries
Always consider the environmental issues and follow local regulations when disposing of batteries.
18. If you install the apparatus in a built-in installation, such as a bookcase or rack, ensure that there is adequate ventilation.
Leave 30 cm (12") of free space at the top and sides and 10 cm (4") at the rear. The rear edge of the shelf or board above the apparatus shall be set 10 cm (4") away from the rear panel or wall, creating a flue-like gap for warm air to escape.

Precautions

1. **Recording Copyright**—Unless it's for personal use only, recording copyrighted material is illegal without the permission of the copyright holder.
2. **AC Fuse**—The AC fuse inside the unit is not user-serviceable. If you cannot turn on the unit, contact your Onkyo dealer.
3. **Care**—Occasionally you should dust the unit all over with a soft cloth. For stubborn stains, use a soft cloth dampened with a weak solution of mild detergent and water. Dry the unit immediately afterwards with a clean cloth. Don't use abrasive cloths, thinners, alcohol, or other chemical solvents, because they may damage the finish or remove the panel lettering.

4. **Power**

WARNING

BEFORE PLUGGING IN THE UNIT FOR THE FIRST TIME, READ THE FOLLOWING SECTION CAREFULLY.

AC outlet voltages vary from country to country. Make sure that the voltage in your area meets the voltage requirements printed on the unit's rear panel (e.g., AC 230 V, 50 Hz or AC 120 V, 60 Hz).

The power cord plug is used to disconnect this unit from the AC power source. Make sure that the plug is readily operable (easily accessible) at all times.

For models with **[POWER]** button, or with both **[POWER]** and **[ON/STANDBY]** buttons:

Pressing the **[POWER]** button to select OFF mode does not fully disconnect from the mains. If you do not intend to use the unit for an extended period, remove the power cord from the AC outlet.

For models with **[ON/STANDBY]** button only:

Pressing the **[ON/STANDBY]** button to select Standby mode does not fully disconnect from the mains. If you do not intend to use the unit for an extended period, remove the power cord from the AC outlet.

5. **Preventing Hearing Loss**

Caution

Excessive sound pressure from earphones and headphones can cause hearing loss.

6. **Batteries and Heat Exposure**

Warning

Batteries (battery pack or batteries installed) shall not be exposed to excessive heat as sunshine, fire or the like.

7. **Never Touch this Unit with Wet Hands**—Never handle this unit or its power cord while your hands are wet or damp. If water or any other liquid gets inside this unit, have it checked by your Onkyo dealer.

8. **Handling Notes**

- If you need to transport this unit, use the original packaging to pack it how it was when you originally bought it.
- Do not leave rubber or plastic items on this unit for a long time, because they may leave marks on the case.
- This unit's top and rear panels may get warm after prolonged use. This is normal.
- If you do not use this unit for a long time, it may not work properly the next time you turn it on, so be sure to use it occasionally.

For British models

Replacement and mounting of an AC plug on the power supply cord of this unit should be performed only by qualified service personnel.

IMPORTANT

The wires in the mains lead are coloured in accordance with the following code:

Blue: Neutral

Brown: Live

As the colours of the wires in the mains lead of this apparatus may not correspond with the coloured markings identifying the terminals in your plug, proceed as follows:

The wire which is coloured blue must be connected to the terminal which is marked with the letter N or coloured black.

The wire which is coloured brown must be connected to the terminal which is marked with the letter L or coloured red.

IMPORTANT

The plug is fitted with an appropriate fuse. If the fuse needs to be replaced, the replacement fuse must approved by ASTA or BSI to BS1362 and have the same ampere rating as that indicated on the plug. Check for the ASTA mark or the BSI mark on the body of the fuse.

If the power cord's plug is not suitable for your socket outlets, cut it off and fit a suitable plug. Fit a suitable fuse in the plug.

For European Models

Declaration of Conformity	
We, ONKYO EUROPE ELECTRONICS GmbH LIEGNITZERSTRASSE 6, 82194 GROEBENZELL, GERMANY	
declare in own responsibility, that the ONKYO product described in this instruction manual is in compliance with the corresponding technical standards such as EN60065, EN55013, EN55020 and EN61000-3-2, -3-3.	
GROEBENZELL, GERMANY	 K. MIYAGI
ONKYO EUROPE ELECTRONICS GmbH	

Features

- 140 W/Ch (4 ohm, 20 Hz - 20 kHz, 0.05%, 2 Channels Driven, IEC)
- A WRAT (Advanced Wide Range Amplifier Technology)
- DIDRC (Dynamic Intermodulation Distortion Reduction Circuitry)
- Quad Push-Pull Amplification Design with Three-Stage Inverted Darlington Circuitry
- Symmetrical Layout of Power Stage
- Four Large 18,000 μ F Capacitors
- Anti-Vibration Aluminum Panels for Front and Sides
- Side-mounted Circuit Board Construction to Reduce Vibration
- Separate Digital/Analog Circuitry
- Low-noise Static Display
- PLL Ultra-Low Jitter Technology
- Separate Wolfson 192 kHz/24-Bit DACs (WM8742) for L/R Channels
- Direct Mode
- Tone Control (Bass/Treble)
- Balance Control
- Independent Headphone Amplifier
- Discrete Phono Equalizer
- Phono Input (MM/MC)
- De-emphasis Function*1
- USB Digital Input for 192 kHz/24-Bit HD Audio from PC*2
- AES/EBU Balanced Digital Input with XLR Connector
- 4 Digital Inputs (1 AES/EBU, 2 Coaxial and 1 Optical)
- Gold-Plated, Machined Solid Brass RCA Inputs
- Gold-Plated Large Speaker Posts
- Display Dimmer (Normal/Dim/Off)

*1 This function only applies to the following sampling rates: 32 kHz, 44.1 kHz, 48 kHz. Other rates are not supported.

*2 Playback of PC audio requires dedicated software that can be downloaded from the Onkyo web site. Audio signals of up to 32 bit can be input. However, the resulting output will be equivalent to a quality of 24 bit.

Technologies

1. A WRAT (Advanced Wide Range Amplifier Technology)

The A-9000R employs a host of proprietary Onkyo technologies to ensure optimal audio performance.

– DIDRC (Dynamic Intermodulation Distortion Reduction Circuitry)

Since the advent of digital audio, the values of S/N (signal-to-noise) ratio have risen significantly. However, it is also recognized that in terms of perceived S/N, analog audio sources are not inferior to digital sources.

Generally, S/N measures the ratio when sound is and not produced, but takes no account of the noise generated during sound reproduction.

For a long time, Onkyo has focused and made extensive research on the S/N when sound is produced (dynamic S/N). Using a mechanism that captures the noise beyond audible range, it has been possible to determine that both dynamic S/N and perceived S/N aggravate during music reproduction.

Although frequencies above 20 kHz are beyond human hearing, it is well known that a beat can be perceived if different signals are overlapped at such frequencies.

During the analog audio era, no significant signals were entering beyond the audible range. However, the digital era has made recording beyond the audible range possible and the generated beat is now perceivable.

With Onkyo's DIDRC technology, a new approach is introduced which prevents such beat from penetrating the audible range.

– Low Negative-Feedback Design

Conventional amplifiers make extensive use of negative feedback (NFB), whereby part of the output signal is re-input in order to improve the S/N ratio across a wide frequency range.

However, too much NFB makes a system susceptible to counter-electromotive force from the speakers, resulting in a drop in perceived sound quality. To avoid this, Onkyo focuses on improving the frequency response and reducing distortion, without relying so much on NFB.

We use a low negative-feedback design incorporating audiophile-grade, close-tolerance components, to achieve a frequency response, out to 100 kHz.

– Closed Ground-Loop Circuits

If an amplifier's ground potential (voltage) fluctuates during playback, noise is likely to result. In an open-loop circuit design, where all circuits wire connected to the power supply via a single loop (as on many amplifiers), the noise is compounded. To avoid this, the A-9000R employs a sophisticated closed-circuit design in which each circuit has a separate link to the power supply. This helps to cancel individual circuit noise and keep the ground potential free of distortion.

– HICC (High Instantaneous-Current Capability)

When an amplifier outputs an audio signal, the connected speakers accumulate energy, reflex, and send energy back to the amplifier. The amplifier must then immediately cancel the speakers' reflex energy and instantaneously send out the next signal. The same high current required to achieve this is also necessary to handle speaker impedance, fluctuations, which can force an amplifier to provide four to six times its usual current load. The A-9000R's instantaneous current capability ensures that audio output is not affected by power limitations.

– Symmetrical Twin-Monaural Construction

Power devices for the left and right channels of the A-9000R are aligned symmetrically. Each channel has the same electrical and structural design, and signal pathways are uniform in length. This helps to minimize errors in stereophonic playback.

2. Quad Push-Pull Amplification Design with Three-Stage Inverted Darlington Circuitry

Three-Stage Inverted Darlington Circuitry brings greater efficiency to the A-9000R integrated amp by employing a low-NFB design to maintain voltage stability and enhance transient response. Extremely sensitive to oscillations, this circuitry requires very advanced control technology in order to be incorporated into the amplifier. Breaking further new ground, the A-9000R employs two extra transistors for each channel in a “quad push-pull” design that significantly enhances amplification power.

3. PLL (Phase Locked Loop) Ultra-Low Jitter Technology

Jitter is an unwanted side-effect of the digital-to-analog conversion process caused by fluctuations in the time domain of a digital signal. PLL ultra-low jitter technology reduces jitter by comparing the input and output phases of the digital signal and creating an accurate clock waveform. This enhances the precision of digital signal processing and noticeably improves perceived audio quality.

4. Side-mounted Circuit Board Construction

Rather than being directly connected to the chassis base, the circuit boards inside the A-9000R are cushioned by internal struts and affixed to the front, side, and rear panels. This method of construction prevents vibrations from the chassis from adversely affecting the circuit boards.

5. Playback of Various Music Sources Including PC Audio via USB

Using the USB port on the rear panel of the A-9000R, you can connect your PC and play back 192 kHz/24-bit HD audio formats*.

* Playback of PC audio requires dedicated software that can be downloaded from the Onkyo web site. Audio signals of up to 32 bit can be input. However, the resulting output will be equivalent to a quality of 24 bit.

Block Diagram

 DIDRC
(Dynamic Intermodulation Distortion Reduction Circuitry)

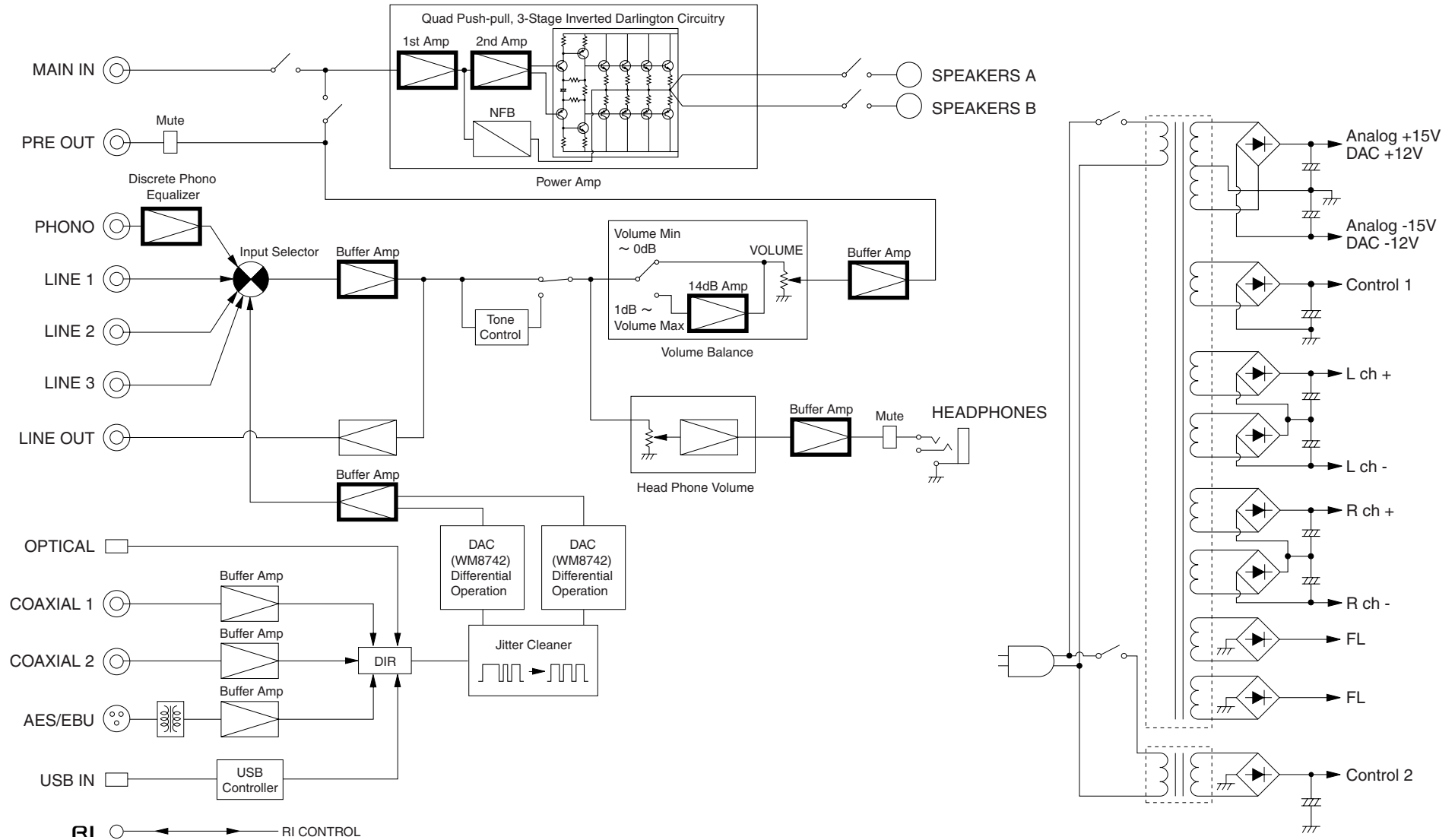

Supplied Accessories

Make sure you have the following accessories:

Remote controller and two batteries

- Remote controller (RC-829S) (1)
- Batteries (R03) (2)

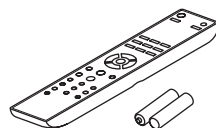

Power cord

- Power cord (1.8 m) (1)
(Plug type varies from country to country.)

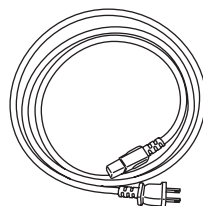

* In catalogs and on packaging, the letter at the end of the product name indicates the color.
Specifications and operations are the same regardless of color.

Thank you for purchasing an Onkyo Integrated Amplifier. Please read this manual thoroughly before making connections and plugging in the unit. Following the instructions in this manual will enable you to obtain optimum performance and listening enjoyment from your new Integrated Amplifier. Please retain this manual for future reference.

Contents

Introduction

Important Safety Instructions	2
Precautions.....	3
Features	4
Technologies	5
Block Diagram	7
Supplied Accessories	8
Before Using the Integrated Amplifier	10
Installing the Batteries	10
Using the Remote Controller	10
Installing the Integrated Amplifier	10
Getting to Know the Integrated Amplifier	11
Front Panel	11
Rear Panel.....	13
Remote Controller.....	14

Connections

Connections	15
Connecting Your Speakers.....	15
Cable and Jacks	17
Connecting the Power Cord.....	18
Connecting a CD Player	19
Connecting an Onkyo Dock	20
Connecting a Tuner	21
Connecting Onkyo RI Components.....	22
Connecting a Turntable	23
Connecting a Cassette Tape Deck	23
Connecting a Recording Component.....	24
Using the Integrated Amplifier as a Preamplifier	25
Separating the Pre-amp and Main Amp Units	26
Using the Integrated Amplifier as a Power Amplifier.....	27

Turning On & Basic Operations

Basic Operations.....	28
Turning On/Off the Integrated Amplifier.....	28
Selecting Speakers A and Speakers B	29
Adjusting the Volume	29
Selecting the Input Source.....	29
Adjusting the Display Brightness	30
Using the Direct Function	30
Adjusting the Bass, Treble and Balance.....	31
Muting the Sound.....	31
Changing the Display Information.....	32
Using Headphones	32
Controlling Other Onkyo Components	33
Controlling the Onkyo CD Player.....	33
Controlling the Onkyo Dock	33
Controlling the Onkyo Network Tuner.....	34
Using the Integrated Amplifier as a USB Audio Device	35
Connecting a PC.....	35
Installing USB drivers	35
Playing Music Files from the PC.....	35

Advanced Operations

Custom Setup.....	36
Changing Input Names.....	36
Skipping Unused Inputs.....	37
Setting the Headphone Level	37
Setting the Auto Standby Function	38
Setting the Route.....	39
Restoring the Default Settings.....	40

Others

Troubleshooting.....	41
Specifications.....	43

Before Using the Integrated Amplifier

Installing the Batteries

- 1 To open the battery compartment, press the small hollow and slide the cover.

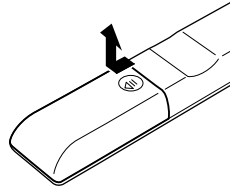

- 2 Insert the two supplied batteries (R03) in accordance with the polarity diagram inside the battery compartment.

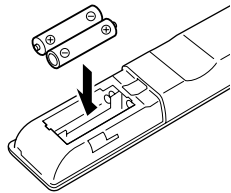

- 3 Replace the cover and slide it shut.

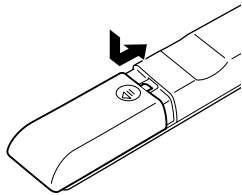

Note

- If the remote controller doesn't work reliably, try replacing the batteries.
- Don't mix new and old batteries or different types of batteries.
- If you intend not to use the remote controller for a long time, remove the batteries to prevent damage from leakage or corrosion.
- Remove expired batteries as soon as possible to prevent damage from leakage or corrosion.

Using the Remote Controller

To use the remote controller, point it at the integrated amplifier's remote control sensor, as shown below.

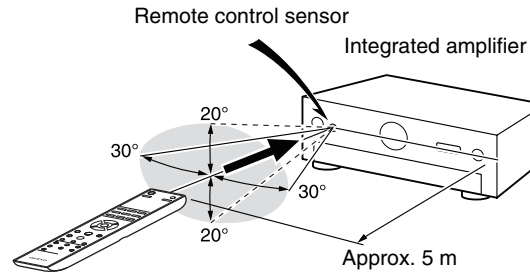

Note

- The remote controller may not work reliably if the integrated amplifier is subjected to bright light, such as direct sunlight or inverter-type fluorescent lights. Keep this in mind when installing.
- If another remote controller of the same type is used in the same room, or the integrated amplifier is installed close to equipment that uses infrared rays, the remote controller may not work reliably.
- Don't put anything, such as a book, on the remote controller, because the buttons may be pressed inadvertently, thereby draining the batteries.
- The remote controller may not work reliably if the integrated amplifier is installed in a rack behind colored glass doors. Keep this in mind when installing.
- The remote controller will not work if there's an obstacle between it and the integrated amplifier's remote control sensor.

Installing the Integrated Amplifier

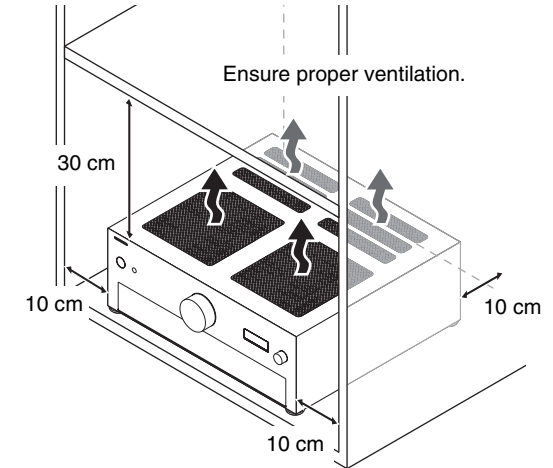

Install the integrated amplifier on a sturdy rack or shelf. Position it so that its weight is evenly dispersed on its four legs. Do not install the integrated amplifier in a place with vibration or an unstable location.

The integrated amplifier is designed to have high conversion efficiency, however, its temperature will become much higher than other audio equipment. Therefore, make sure not to hamper heat dissipation by ensuring proper ventilation.

Getting to Know the Integrated Amplifier

Front Panel

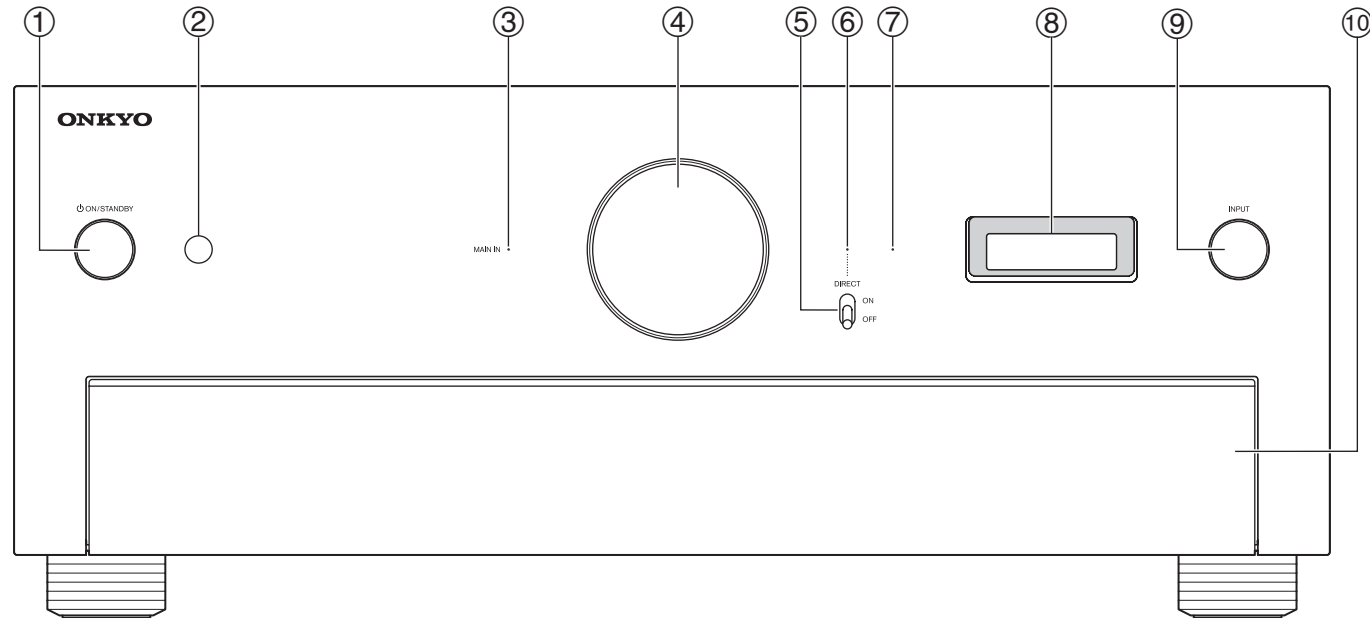

For detailed information, see the pages in parentheses.

- ① **ON/STANDBY button** (→ page 28)
Sets the integrated amplifier to On or Standby.
- ② **Remote control sensor** (→ page 10)
Receives control signals from the remote controller.
- ③ **MAIN IN LED** (→ page 27)
Lights when the integrated amplifier is used as a power amplifier (Main mode).
- ④ **Volume controller** (→ page 29)
Adjusts the volume.
- ⑤ **DIRECT switch** (→ page 30)
Enables or disables the Direct function.
- ⑥ **DIRECT LED** (→ page 30)
Lights when the integrated amplifier is in Direct mode.
- ⑦ **Display Off LED** (→ page 30)
Lights when the information display is turned off.
- ⑧ **Information display**
Displays various information.
- ⑨ **INPUT selector** (→ pages 29, 35)
Selects the input sources in sequence. It is also used to select settings.

- ⑩ **Front flap**
Gently push on the lower end of the front panel to open the flap.

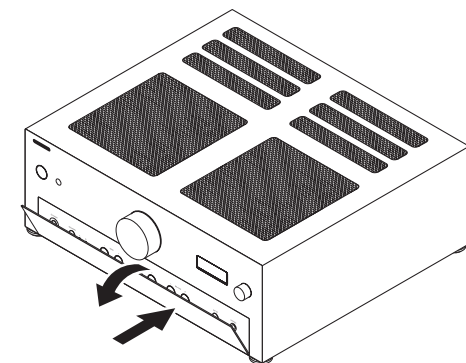

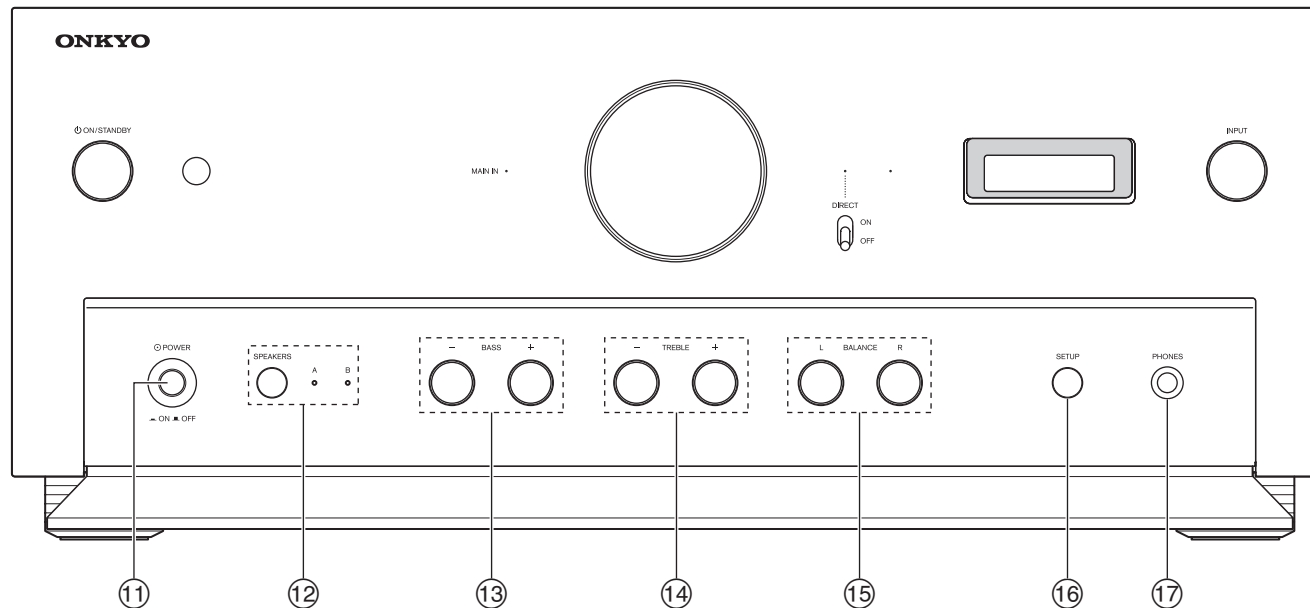

For detailed information, see the pages in parentheses.

⑪ **POWER switch** (→ page 28)

This is the main power switch. When set to the **OFF** position (■), the integrated amplifier is completely shut down. It must be switched to the **ON** position (■) to set the integrated amplifier to On or Standby.

⑫ **SPEAKERS button and A/B LEDs** (→ page 29)

Selects Speakers A, Speakers B, or both. The **A** and **B** LEDs show which speaker set is selected.

⑬ **BASS +/- buttons** (→ page 31)

Adjusts the level of bass sounds. Press the button once to display the current level value.

⑭ **TREBLE +/- buttons** (→ page 31)

Adjusts the level of treble sounds. Press the button once to display the current level value.

⑮ **BALANCE L/R buttons** (→ page 31)

Adjusts the balance of left and right channels.

⑯ **SETUP button** (→ page 36)

Selects and confirms settings.

⑰ **PHONES jack** (→ page 32)

Connects headphones with a standard plug.

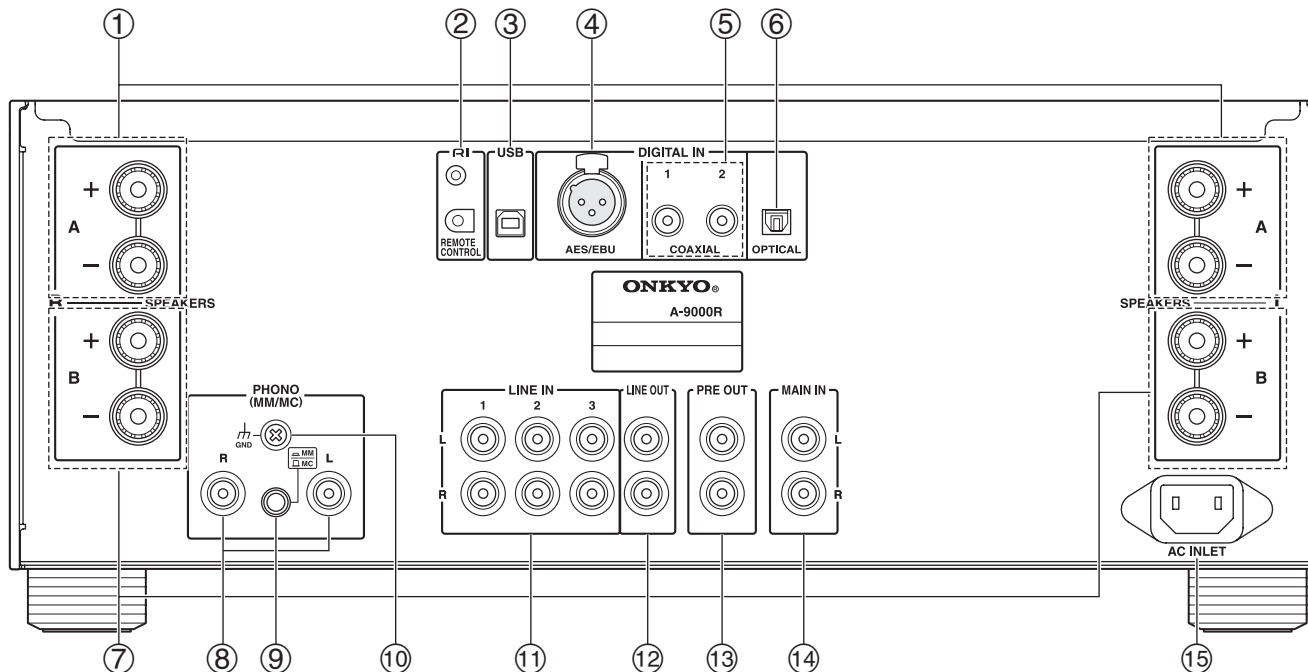

① **SPEAKERS A terminals**

Connect Speakers A.

② **RI REMOTE CONTROL jacks**

Connect Onkyo components such as Onkyo Docks, CD Players, or Network Tuner with **RI** (Remote Interactive) jacks.

③ **USB port**

Connects a PC. The music files of your PC are played through the integrated amplifier.

④ **DIGITAL IN AES/EBU jack**

Connects components such as CD players with balanced AES/EBU output.

Note

- Be careful not to connect components with analog XLR output.

⑤ **DIGITAL IN COAXIAL 1/2 jacks**

Connect components such as CD players with coaxial digital audio output.

⑥ **DIGITAL IN OPTICAL jack**

Connects components such as CD players with optical digital audio output.

⑦ **SPEAKERS B terminals**

Connect Speakers B.

⑧ **PHONO (MM/MC) L/R jacks**

Connect a turntable with analog audio output.

⑨ **MM/MC selector**

Set this selector according to the turntable's cartridge format (≡ **MM**/□ **MC**).

⑩ **GND screw**

Connects the turntable's ground wire.

⑪ **LINE IN 1/2/3 L/R jacks**

Connect playback devices with analog audio output.

⑫ **LINE OUT L/R jacks**

Connect components such as analog line-level sources. The input signals are output with no level adjustment.

⑬ **PRE OUT L/R jacks**

Connect a power amplifier when the integrated amplifier is used as a preamplifier (Pre mode).

⑭ **MAIN IN L/R jacks**

Connect a preamplifier when the integrated amplifier is used as a power amplifier (Main mode).

⑮ **AC INLET**

Connects the supplied power cord. The other end of the power cord should be connected to a suitable wall outlet.

See "Connections" for connection information (→ **pages 15 to 27**).

For detailed information, see the pages in parentheses.

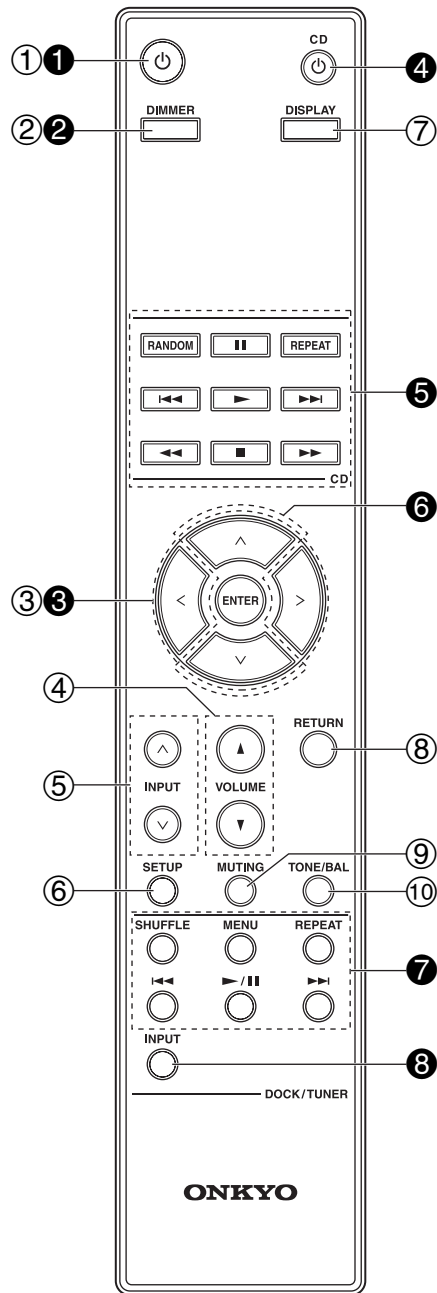

- ① **⏻ button (→ page 28)**
Sets the integrated amplifier to On or Standby.
- ② **DIMMER button (→ page 30)**
Adjusts the display brightness.
- ③ **^/∇/</> and ENTER buttons**
Select and adjust settings.
- ④ **VOLUME ▲/▼ buttons (→ page 29)**
Adjust the volume of the integrated amplifier.
- ⑤ **INPUT ^/∇ buttons (→ page 29)**
Select an input source.
- ⑥ **SETUP button (→ page 36)**
Enters the Setup menu.
- ⑦ **DISPLAY button (→ page 32)**
Displays the current input and settings.
- ⑧ **RETURN button**
Returns to the previous display when changing settings.
- ⑨ **MUTING button (→ page 31)**
Mutes or unmutes the integrated amplifier.
- ⑩ **TONE/BAL button (→ page 31)**
Adjusts the tone (bass/treble) and balance of the integrated amplifier.

You can also use the remote controller to control your Onkyo CD Player (e.g. C-7000R), Onkyo Dock, or Onkyo Network Tuner (e.g. T-4070).

📄 Note

- Make sure the remote controller is pointed at the CD player when using it.
- With some components, the remote controller may not work, or only partially.
- To control the Onkyo Dock and Onkyo Network Tuner, an **RI** connection is required (→ page 22).
- Refer to the manuals supplied with your Onkyo CD Players, Network Tuner or RI Docks.

■ Controlling the Onkyo CD player (→ page 33)

- ④ **⏻ CD button**
- ⑤ **Playback mode buttons**

■ Controlling the Onkyo Dock (→ page 33)

- ① **⏻ button**
- ② **DIMMER button**
- ⑥ **^/∇ and ENTER buttons**
- ⑦ **Dock control buttons**

■ Controlling the Onkyo Network Tuner (→ page 34)

- ① **⏻ button**
- ② **DIMMER button**
- ③ **^/∇/</> and ENTER buttons**
- ⑦⑧ **Tuner control buttons**

Connections

Connecting Your Speakers

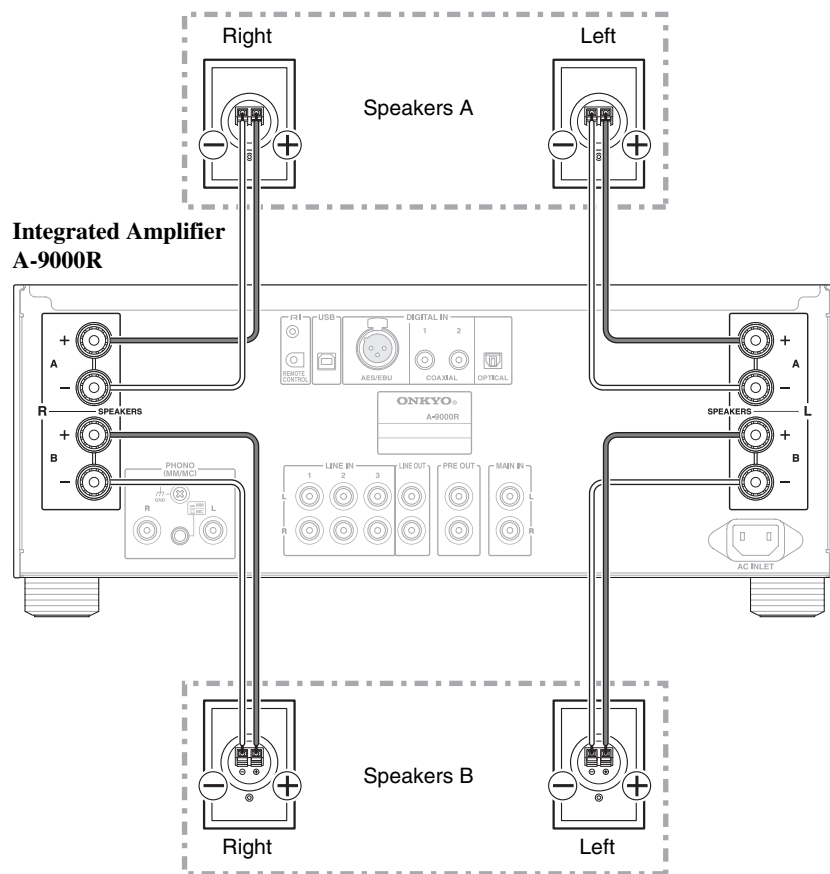

Strip 15 to 20 mm of insulation from the ends of the speaker cables, and twist the bare wires tightly, as shown.

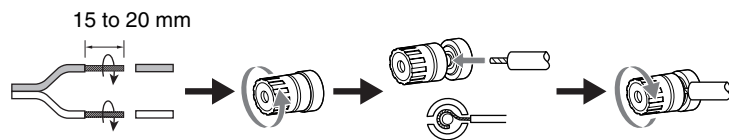

Note

- Make sure that the wires do not touch metal parts on the back panel or elsewhere.
- Y plugs cannot be connected.
- Two sets of speakers (Speakers A and Speakers B) can be connected to the integrated amplifier. You can select which speakers to output audio to when listening to music. You can also output audio from both sets of speakers.
- If you use Speakers A or Speakers B, make sure to use speakers with an impedance of 4 to 16 ohms. If you use Speakers A and Speakers B, make sure to use speakers with an impedance of 8 to 16 ohms. Connecting speakers with an impedance less than 8 ohms may cause the protection circuit to activate.
- Don't connect more than one speaker wire to a single speaker terminal. Doing so could damage the integrated amplifier or cause it to malfunction.
- When using only one speaker, or when playing back monaural audio, don't connect a single speaker to both the left and right speaker terminals.
- Pay close attention to speaker wiring polarity. In other words, connect positive (+) terminals only to positive (+) terminals, and negative (-) terminals only to negative (-) terminals. If you get them the wrong way around, the sound will be out of phase and will feel unnatural.
- Be careful not to short the positive and negative wires. Doing so may damage the integrated amplifier.
- Make sure the metal core of the wire does not have contact with the integrated amplifier's rear panel. Doing so may damage the integrated amplifier.

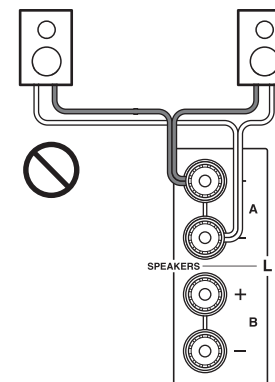
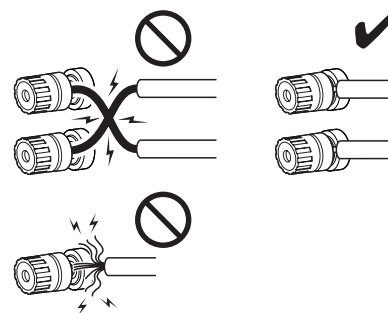

Bi-wiring Connection

Bi-wiring provides improved bass and treble performance. Using terminals of both **SPEAKERS A** and **SPEAKERS B**, it separates high frequency from low frequency signals.

Important:

- Bi-wiring can be used only with speakers that support bi-wiring. Refer to your speaker manual.
- When making the bi-wiring connections, be sure to remove the jumper bars that link the speakers' tweeter (high) and woofer (low) terminals.
- When making the bi-wiring connections, set **SPEAKERS** to **A+B** (→ page 29).



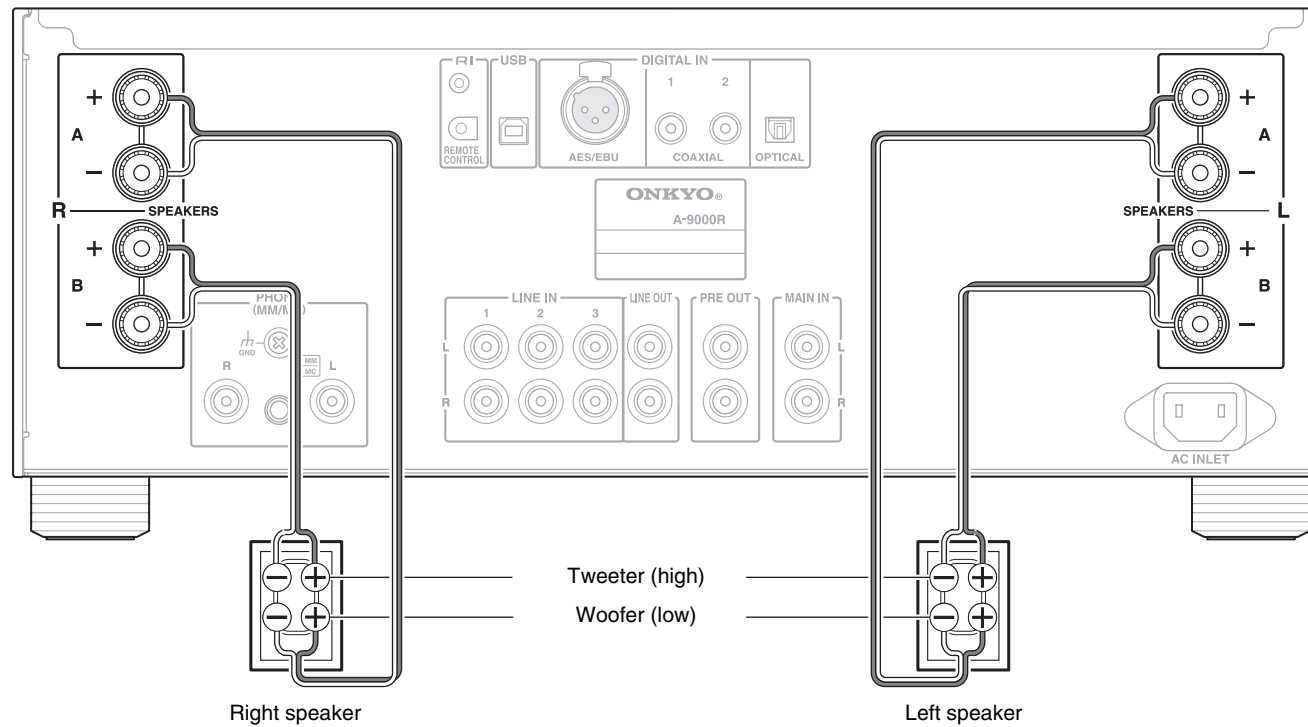











Integrated Amplifier A-9000R

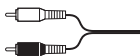

Tip

- As shown on the illustration, the wiring terminals of **SPEAKERS A** are connected to the woofer and **SPEAKERS B** are connected to the tweeter. However, wiring them the other way around is also possible.

Cable and Jacks

Balanced AES/EBU		 AES/EBU	This is a professional digital audio interface. Balanced AES/EBU cables are used for better noise immunity and longer cable runs. The maximum sampling rate for PCM input is 192 kHz/24 bit, 2ch. The integrated amplifier provides 110-ohm impedance matching.
USB digital audio		 USB	USB digital connections allow you to enjoy digital sound. The integrated amplifier supports high-speed USB 2.0. Use Type A-B USB cable. The maximum sampling rate for PCM input is 192 kHz/24 bit, 2ch.
Optical digital audio		 OPTICAL	Optical digital connections allow you to enjoy digital sound such as PCM. The maximum sampling rate for PCM input is 96 kHz/24 bit, 2ch.
Coaxial digital audio*		 COAXIAL Orange	Coaxial digital connections allow you to enjoy digital sound such as PCM. The maximum sampling rate for PCM input is 192 kHz/24 bit, 2ch. The integrated amplifier provides 75-ohm impedance matching.
Analog audio (RCA)		L  R  White Red	Analog audio connections (RCA) carry analog audio.
RI		 RI  REMOTE CONTROL	To use RI (Remote Interactive), you need to connect your Onkyo CD Player, Network Tuner, or RI Dock to the integrated amplifier with an RI cable.

Note

- Push plugs in all the way to make good connections (loose connections can cause noise or malfunctions).
- To prevent interference, keep audio cables away from power cords and speaker cables.
- The integrated amplifier's optical digital jacks have shutter-type covers that open when an optical plug is inserted and close when it's removed. Push plugs in all the way.
- To prevent shutter damage, hold the optical plug straight when inserting and removing.
- Do not use digital audio signals other than PCM.

* An analog audio cable can be used instead of a coaxial cable. However, we recommend that you use a coaxial or a composite video cable.

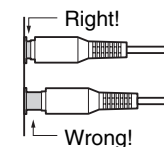

About Balanced Input (AES/EBU Jack)

Plugging the AES/EBU cable

Match the pins and insert the terminal until you hear a “click”. Make sure that the terminal is locked by lightly pulling the connection cable.

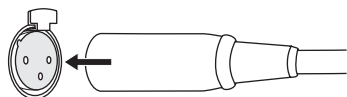

Unplugging the AES/EBU cable

Pull out the connection cable while holding down the lever.

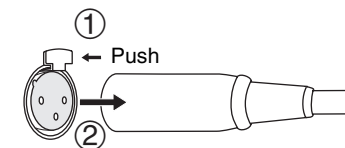

Connecting the Power Cord

Integrated Amplifier A-9000R

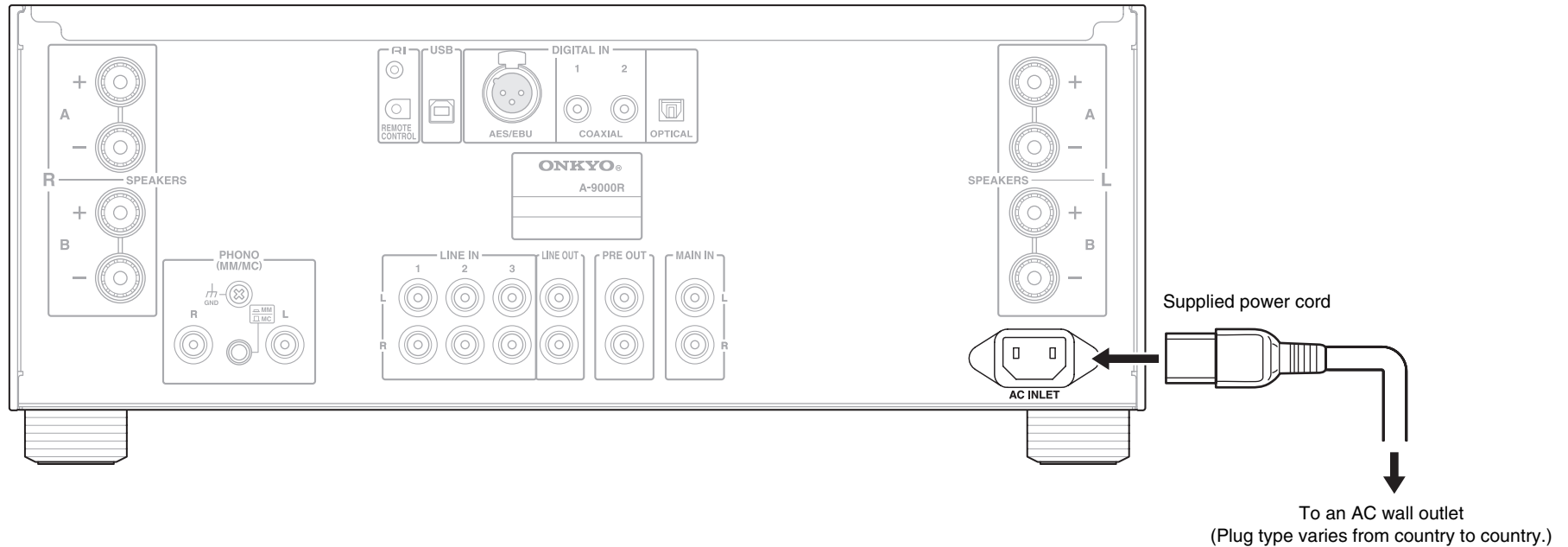

- 1 Connect all of your speakers and components.
- 2 Connect the supplied power cord to the integrated amplifier's **AC INLET**.
- 3 Plug the power cord into an AC wall outlet.

Q Tip

- To reduce noise, do not tie signal cables together with the power cable. Wire them so that they are away from each other.
- Depending on the country, the integrated amplifier may be polarity-sensitive. In this case, plug the power cord in a way that provides the best sound quality.

Note

- **Never disconnect the power cord from the integrated amplifier while the other end is still plugged into a wall outlet.** Doing so may cause an electric shock. Always disconnect the power cord from the wall outlet first, and then the integrated amplifier.
- Turning on the integrated amplifier may cause a momentary power surge that might interfere with other electrical equipment on the same circuit. If this is a problem, plug the integrated amplifier into a different branch circuit.
- Do not use a power cord other than the one supplied with the integrated amplifier. The supplied power cord is designed exclusively for use with the integrated amplifier and should not be used with any other equipment.

Connecting a CD Player

This is an example of connection using the CD Player C-7000R.

Analog Connection

Integrated Amplifier A-9000R

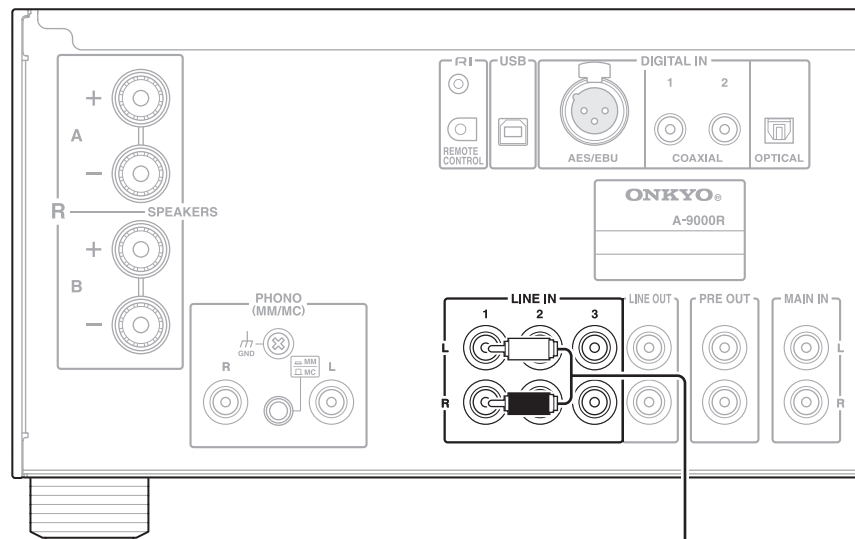

CD Player C-7000R

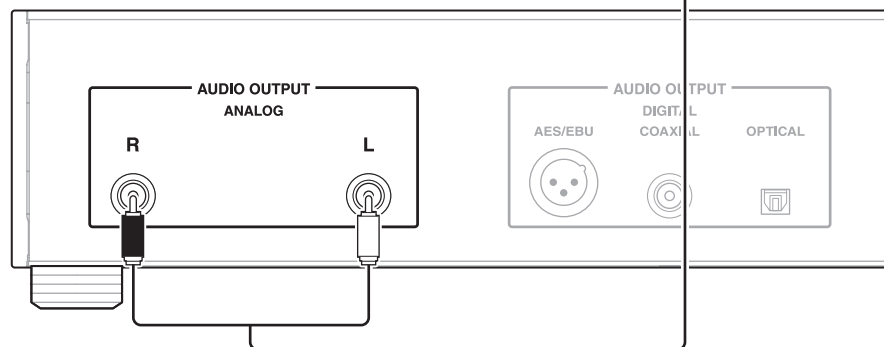

Q Tip

- Connect the CD Player to either of the following jacks: **LINE IN 1/2/3**.

Digital Connection (Coaxial or Optical)

Integrated Amplifier A-9000R

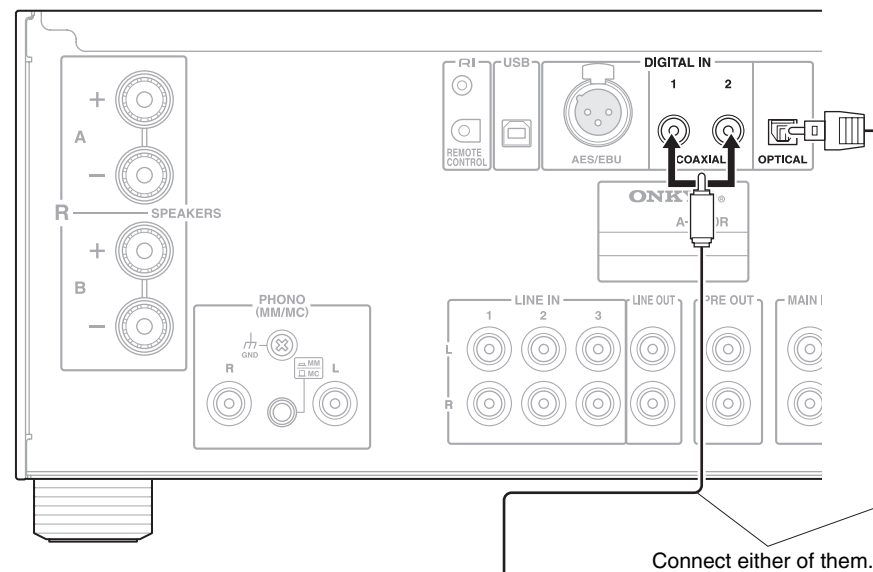

CD Player C-7000R

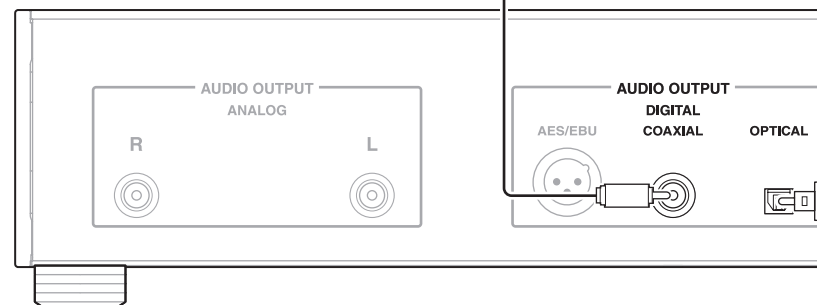

Q Tip

- Connect the CD Player to either of the following jacks: **COAXIAL1/2, OPTICAL**.

Connecting an Onkyo Dock

This is an example of connection using the Onkyo Digital Media Transport.

Digital Connection (AES/EBU)

Integrated Amplifier A-9000R

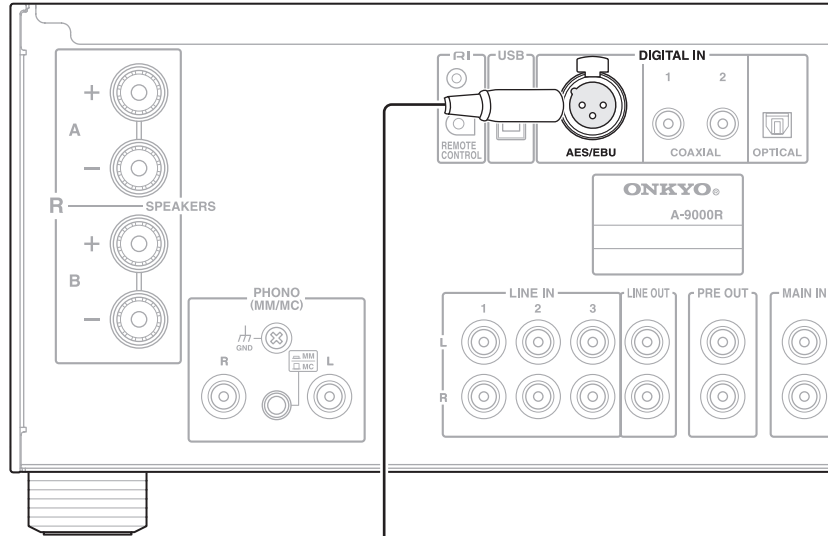

CD Player C-7000R

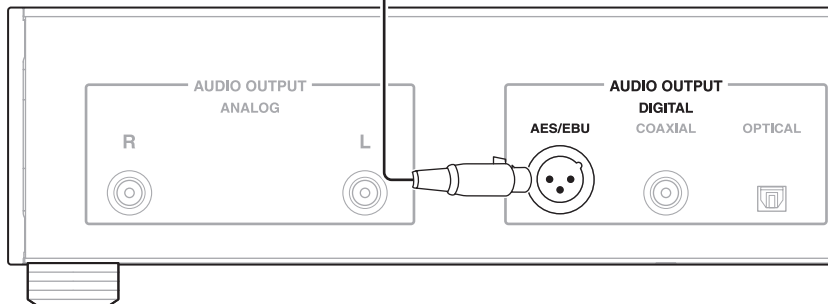

Integrated Amplifier A-9000R

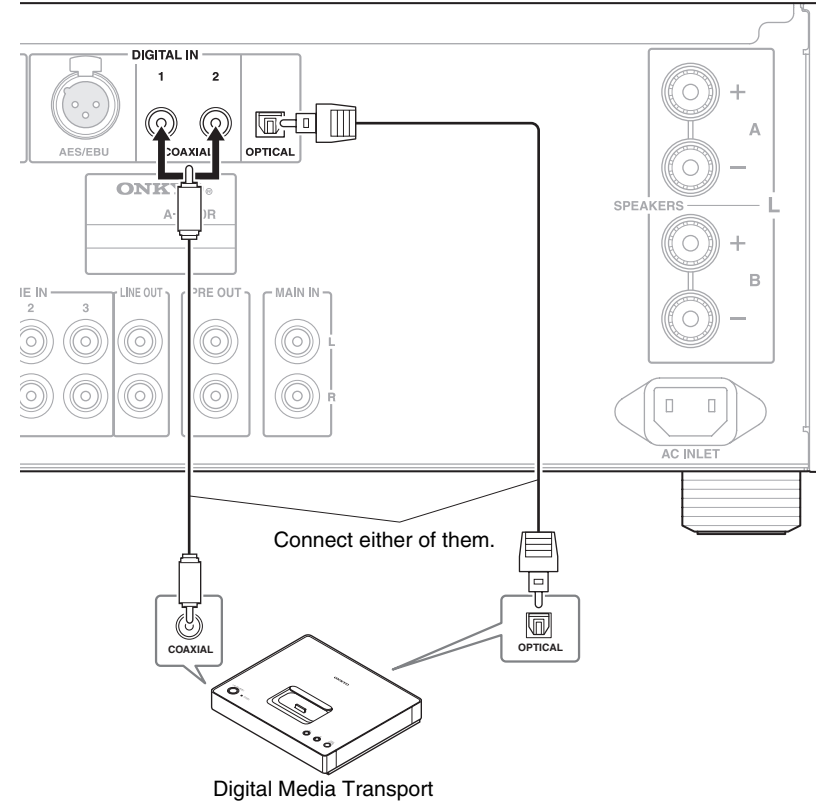

Note

- Use only an Onkyo Dock with digital connections.
- To use the **RI** (Remote Interactive) connection, you need to change the names of inputs (→ pages 22, 36).

Tip

- Connect the Onkyo Dock to either of the following jacks: **COAXIAL1/2, OPTICAL.**

Connecting a Tuner

This is an example of connection using the Network Tuner T-4070.

Analog Connection

Integrated Amplifier A-9000R

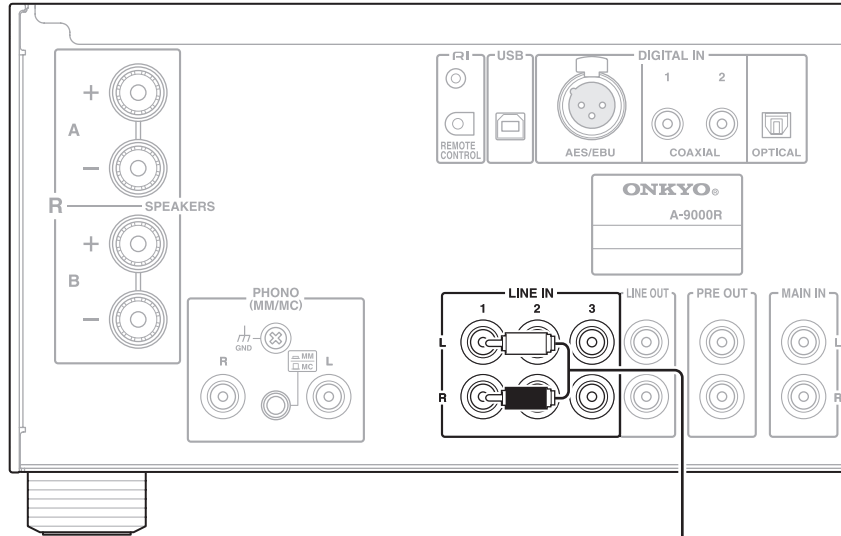

Network Tuner T-4070

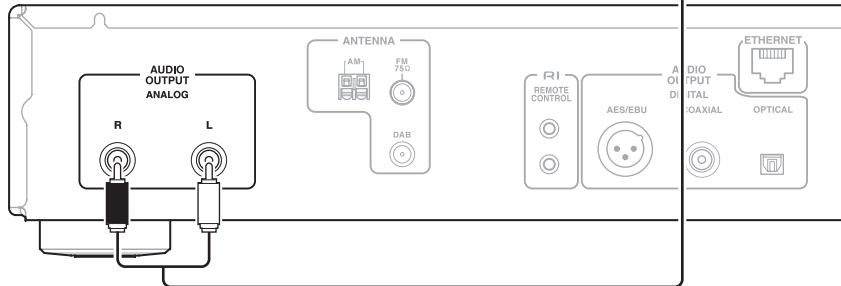

Note

- To use the **RI** (Remote Interactive) connection, you need to change the names of inputs (→ pages 22, 36).

Tip

- Connect your tuner to either of the following jacks: **LINE IN 1/2/3**.

Digital Connection (AES/EBU, Coaxial or Optical)

Integrated Amplifier A-9000R

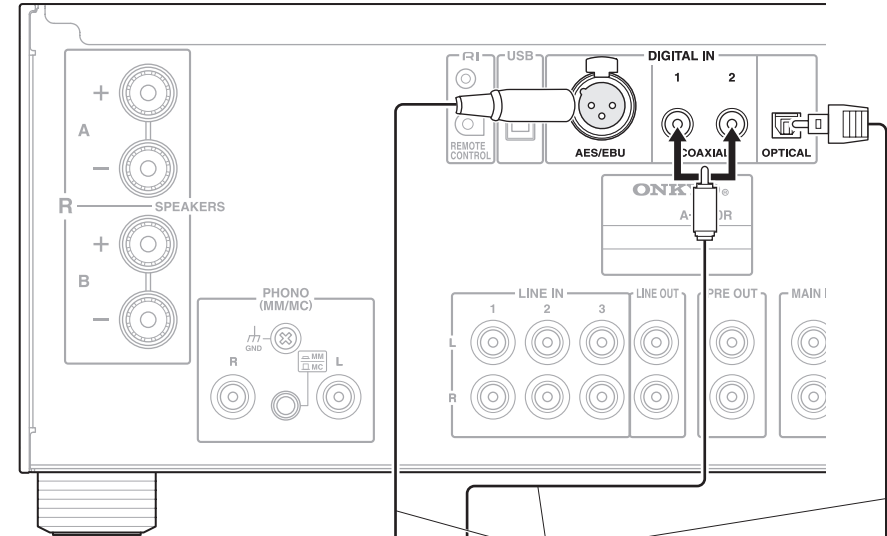

Connect either of them.

Network Tuner T-4070

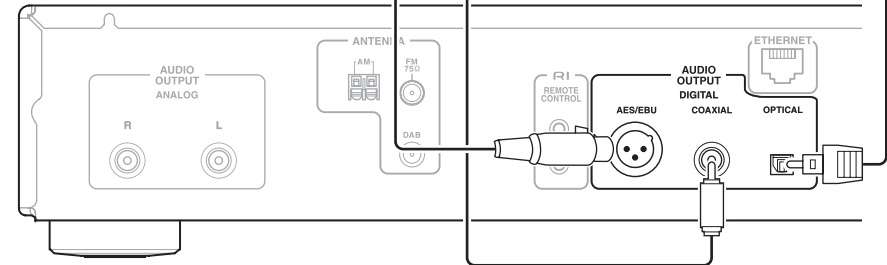

Note

- To use the **RI** (Remote Interactive) connection, you need to change the names of inputs (→ pages 22, 36).

Tip

- Connect the Network Tuner to either of the following jacks: **AES/EBU, COAXIAL1/2, OPTICAL**.

Connecting Onkyo RI Components

Integrated Amplifier A-9000R

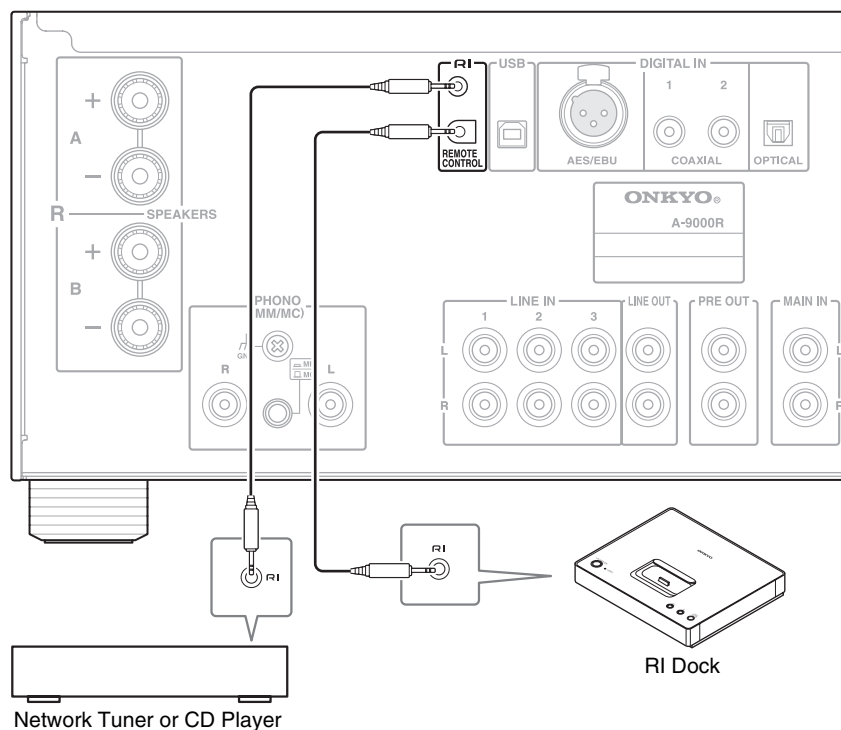

- 1 Change the names of inputs in accordance with each component connected (→ page 36).

Connected component	Names of inputs
CD Player	CD
Network Tuner	TUNER
RI Dock	DOCK

- 2 Make sure that each Onkyo CD Player, Network Tuner or RI Dock is connected (→ pages 19 to 21).
- 3 Make the RI connections (see the illustration).

With **RI** (Remote Interactive), you can use the following special functions:

■ Auto Power On

When you start playback on a component connected via **RI** while the integrated amplifier is on Standby, the integrated amplifier will automatically turn on and select that component as the input source.

■ Direct Change

When playback is started on a component connected via **RI**, the integrated amplifier automatically selects that component as the input source.

■ System Off

When you turn off the integrated amplifier, the components turn off automatically.

■ Remote Control

You can use the integrated amplifier's remote controller to control your other **RI**-capable Onkyo Network Tuner or RI Dock, pointing the remote controller at the integrated amplifier's remote control sensor instead of the component.

Q Tip

- For details on operating the connected components, see “Controlling Other Onkyo Components” (→ page 33).

Note

- Use only **RI** cables for **RI** connections. **RI** cables are supplied with your Onkyo CD Player, Network Tuner or RI Dock.
- If two **RI** jacks are present, you can use either one indifferently as they work the same way.
- Connect only an Onkyo CD Player, Network Tuner or RI Dock to the **RI** jacks. Connecting other manufacturer's components may cause a malfunction.
- Only Onkyo CD Players (e.g. C-7070), Network Tuners (e.g. T-4070), and RI Docks (e.g. ND-S1000) are supported by the integrated amplifier's **RI**. With other components such as MD recorders, the **RI** won't work properly.
- Some components may not support all **RI** functions. Refer to the manuals supplied with your Onkyo CD Players, Network Tuner or RI Docks.
- The CD Players only support the Auto Power On and Direct Change functions.

Connecting a Turntable

Integrated Amplifier A-9000R

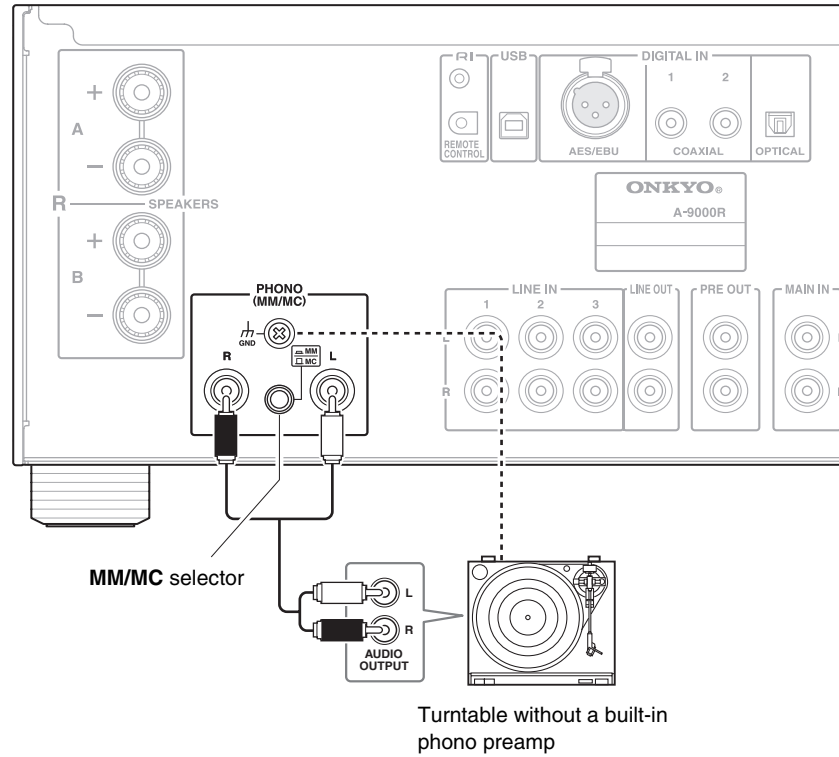

Use the **MM/MC** selector on the back of the integrated amplifier to select either **MM** or **MC**, in accordance with the cartridge format of the turntable.

Remove the short pins plugged into the jacks before connecting a turntable to the **PHONO** inputs.

Note

- Always turn off the integrated amplifier before switching between **MM** and **MC**.

Tip

- If your turntable has a built-in phono preamp, you can connect the turntable to other analog inputs such as **LINE IN 1**.
- If your turntable has a ground wire, connect it to the **GND** screw. With some turntables, connecting the ground wire may produce an audible hum. If this happens, disconnect it.

Connecting a Cassette Tape Deck

Integrated Amplifier A-9000R

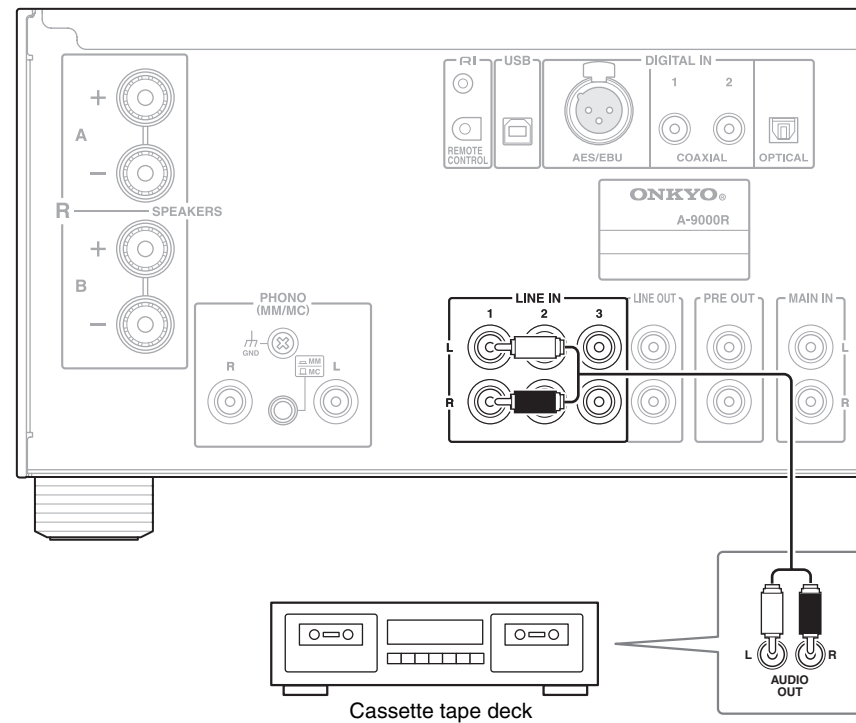

Tip

- Connect your cassette tape deck to either of the following jacks: **LINE IN 1/2/3**.

Connecting a Recording Component

Important:

- Unless you have the full consent of the copyright holder, copyright laws prohibit using your recordings for anything other than personal enjoyment!
- Do not change the integrated amplifier's input while recording. Doing so will cause the audio from the selected component to be recorded.

Note

- Volume adjustments and use of the muting function are not reflected in the signal output from **LINE OUT**.
- Manual tone adjustments using **BASS +/-**, **TREBLE +/-**, **BALANCE L/R**, and **TONE/BAL** are not reflected in the signal output from **LINE OUT**.
- See the manual of the recording component for instructions on correct use.

Integrated Amplifier A-9000R

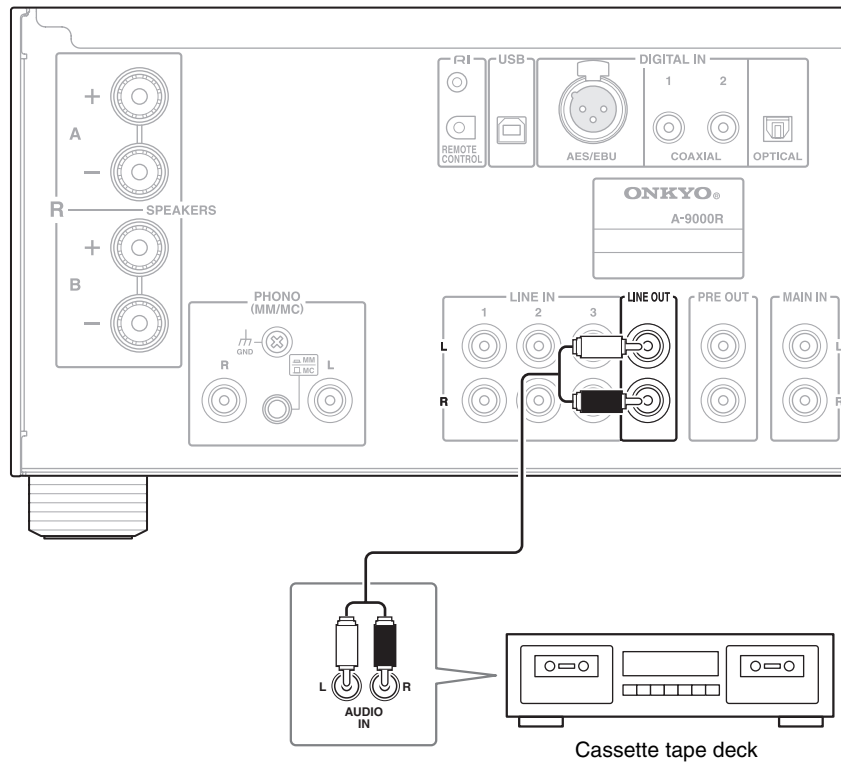

Using the Integrated Amplifier as a Preamplifier

The integrated amplifier can be used as a preamplifier (Pre mode). This mode keeps the heat down, as opposed to when the integrated amplifier is used as a pre-main amplifier. This is an example of connection using the power amplifier M-5000R.

Important:

- In this mode, **SPEAKERS** cannot be used.
- To use this mode, you need to change the “ROUTE” setting (→ [page 39](#)).

Integrated Amplifier A-9000R

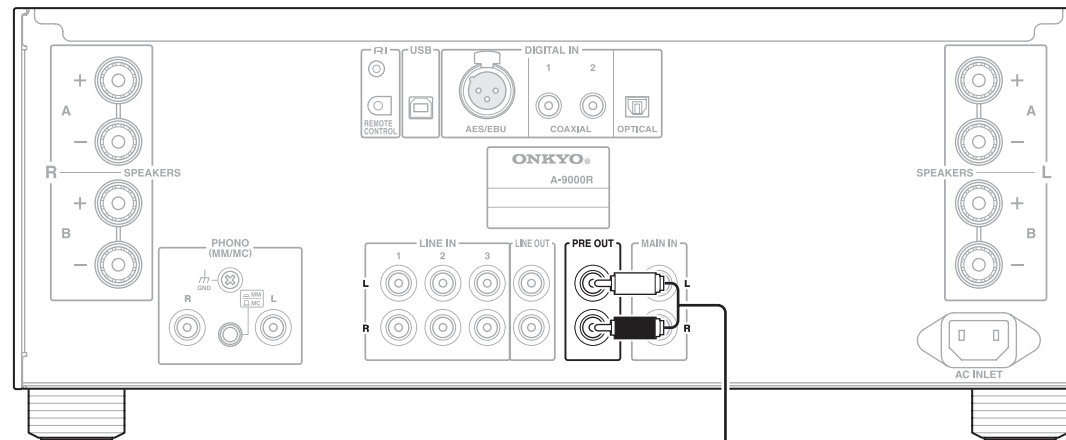

Power Amplifier M-5000R

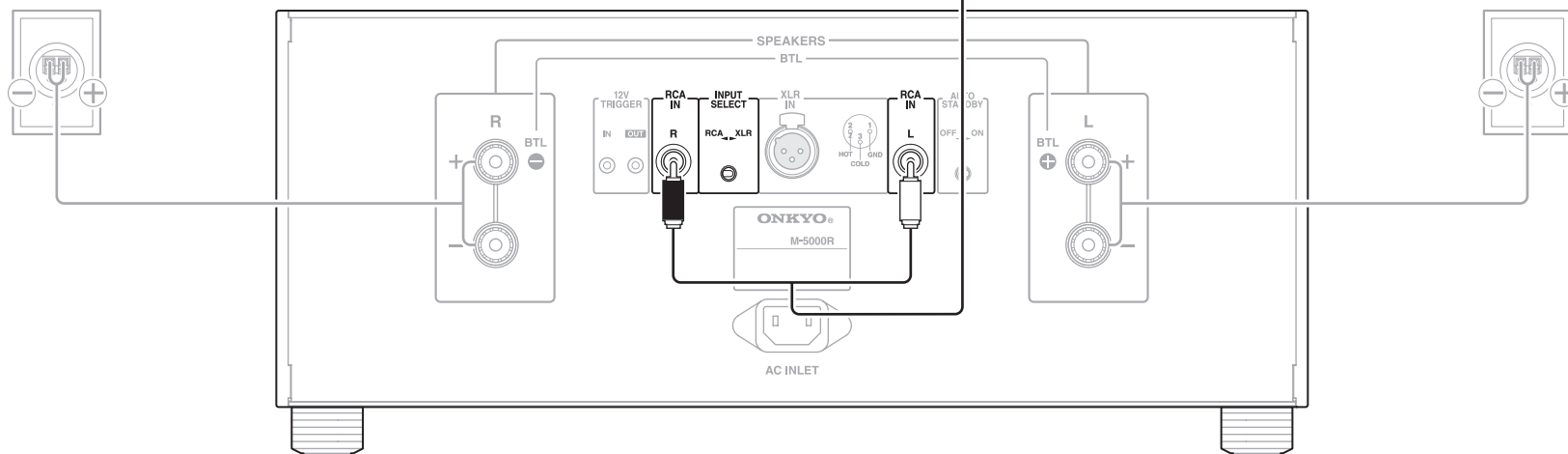

Separating the Pre-amp and Main Amp Units

You can use the integrated amplifier's pre-amp and main amp units individually (Split mode) to connect a sound processor such as a graphic equalizer between the pre-amp and main amp units.

Important:

- Always turn the integrated amplifier off before connecting the **MAIN IN** jacks.
- To use this mode, you need to change the “**ROUTE**” setting (→ [page 39](#)).

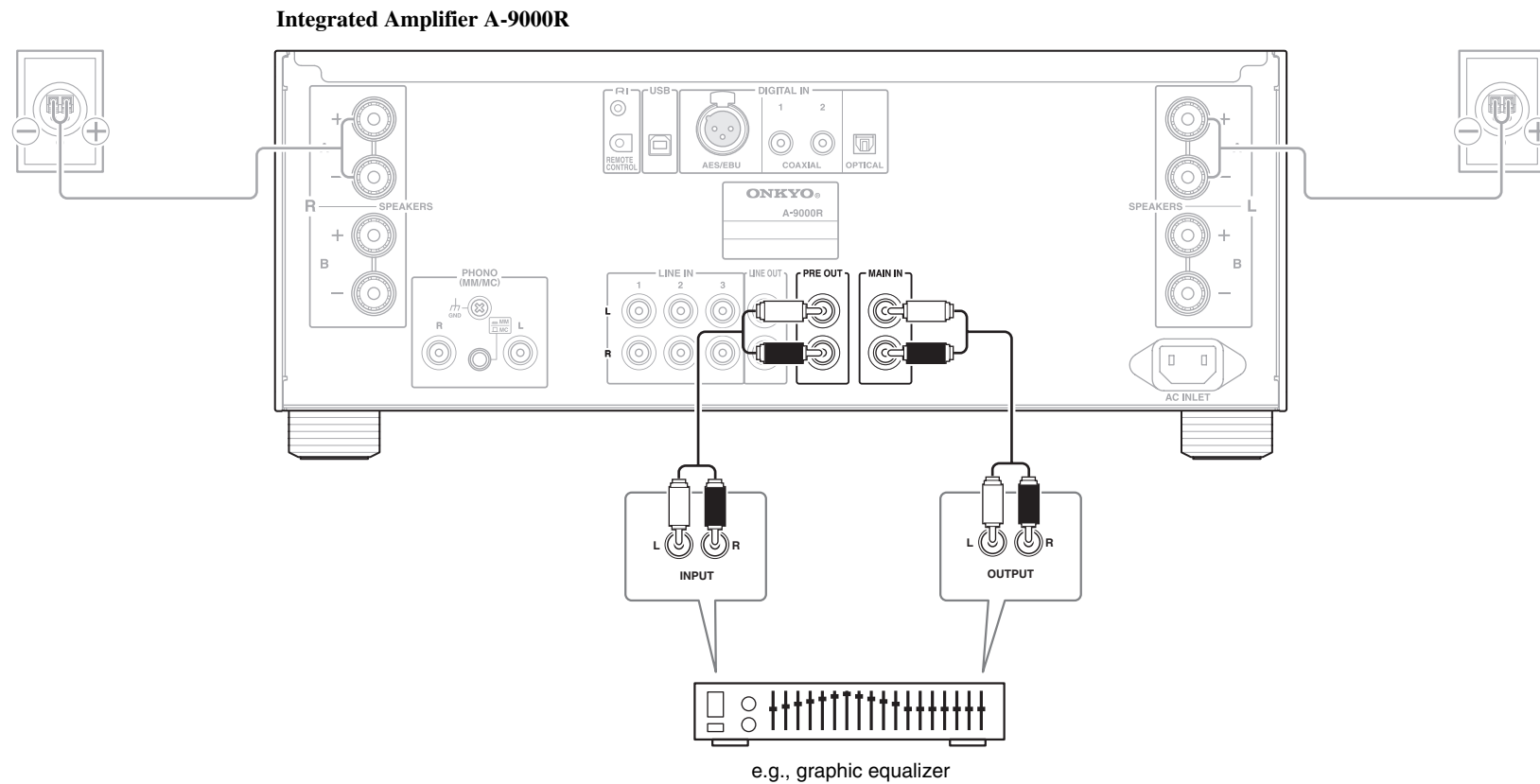

Note

- Depending on the sound processor used, noise may be produced upon switching the integrated amplifier on and off. In this case, turn on each device in the following sequence: sound processor, integrated amplifier. Turn off each device in the following sequence: integrated amplifier, sound processor.

Using the Integrated Amplifier as a Power Amplifier

Combined with a preamplifier of your choice, the integrated amplifier can be used as a power amplifier (Main mode). When it is selected, the **MAIN IN** LED lights. See “Connecting Your Speakers” for connection information (→ **page 15**). This is an example of connection using the preamplifier P-3000R.

Important:

- Always turn the integrated amplifier off before connecting the **MAIN IN** jacks.
- Before setting the integrated amplifier to Main mode, make sure that no component such as a CD player is connected to the **MAIN IN** jacks, as a direct connection may cause a massive blast sound and damage the integrated amplifier or your speakers.
- This mode can be used with the following limitations:
 - The volume level can't be adjusted.
 - Only **SPEAKERS** and **SETUP** can be used.
 - Only the **MAIN IN** and **SPEAKERS** terminals can be used.
 - The Auto Standby function is not available (→ **page 38**).
- To use this mode, you need to change the “**ROUTE**” setting (→ **page 39**).

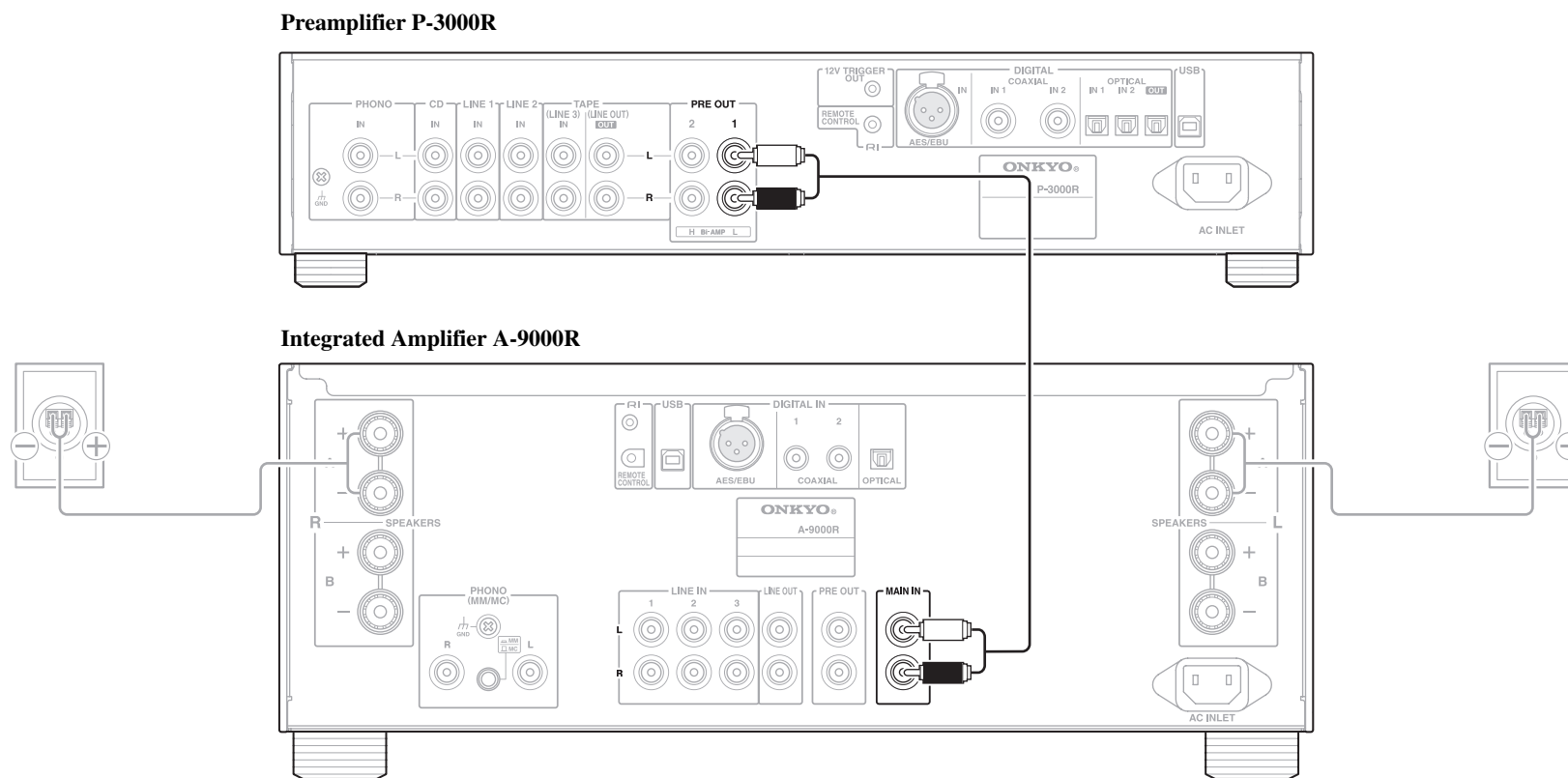

Basic Operations

Turning On/Off the Integrated Amplifier

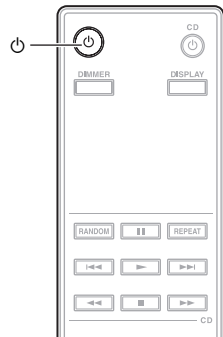
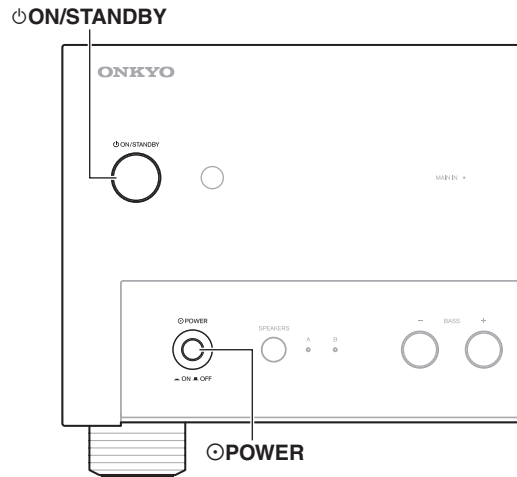

Turning On the Integrated Amplifier

■ Operating with the remote controller

1 Set **ⓄPOWER** to the **ON** position (▲) on the integrated amplifier.

2 Press **Ⓞ**.

The integrated amplifier comes on, and the information display lights.

■ Operating on the integrated amplifier

1 Set **ⓄPOWER** to the **ON** position (▲).

2 Press **ⓄON/STANDBY**.

The integrated amplifier comes on, and the information display lights.

Q Tip

- After showing the volume level from the last session, the message “**MUTING**” flashes on the information display until the speakers or headphones become active.
- After a certain time of warming up, the internal temperature of the integrated amplifier stabilizes, and the sound is softened.
- The integrated amplifier remembers the state when power was last turned off, and returns to that state.

Turning Off the Integrated Amplifier

■ Operating with the remote controller

1 Press **Ⓞ**.

The integrated amplifier enters Standby mode and the information display goes off.

2 To completely shut down the integrated amplifier, set **ⓄPOWER** to the **OFF** position (■) on the integrated amplifier.

■ Operating on the integrated amplifier

1 Press **ⓄON/STANDBY**.

The integrated amplifier enters Standby mode and the information display goes off.

2 To completely shut down the integrated amplifier, set **ⓄPOWER** to the **OFF** position (■).

Q Tip

- For details on power management settings, see “Setting the Auto Standby Function” (→ [page 38](#)).

Selecting Speakers A and Speakers B

You can select to output sound from Speakers A, Speakers B, or both A + B.

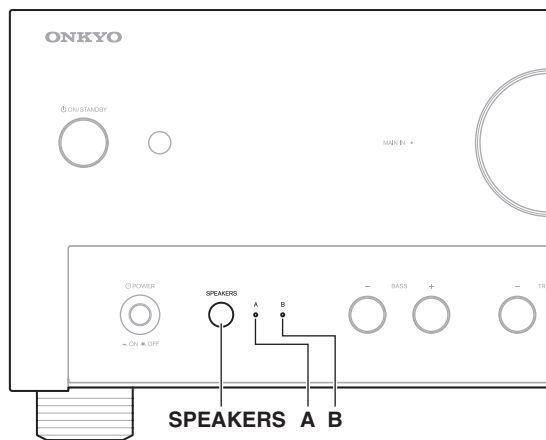

1 Press **SPEAKERS** repeatedly on the integrated amplifier.

The LED of the selected speakers lights.

Note

- While headphones are connected, this setting is disabled.
- When “ROUTE” is set to “PRE”, this setting is disabled (→ [page 39](#)).
- When this setting is set to **A + B**, the impedance of speakers is restricted. For further details, see “Connecting Your Speakers” (→ [page 15](#)).

Adjusting the Volume

You can adjust the volume within the following range:
VOLMIN, -95dB, -90dB, -85dB, -80dB to 14dB, VOLMAX

■ Operating with the remote controller

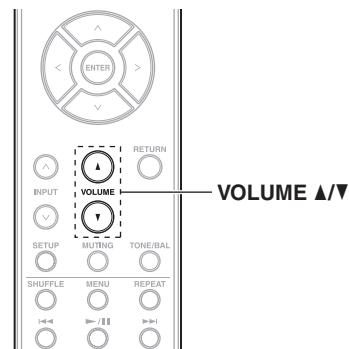

1 Press **VOLUME ▲/▼** repeatedly.

■ Operating on the integrated amplifier

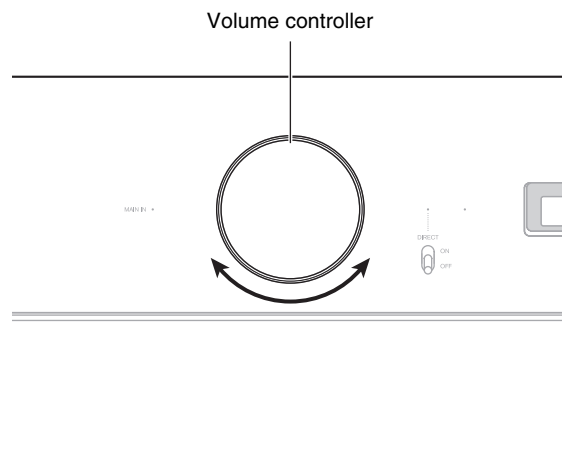

1 Use the **volume controller**.

Q Tip

- The default level is -55 dB.

Selecting the Input Source

You can switch inputs to select the desired source component. Choose an input from the following:
LINE1, LINE2, LINE3, COAX1, COAX2, OPT, AES-EBU, USB, PHONO

■ Operating with the remote controller

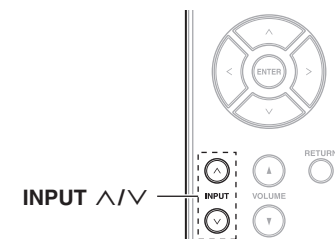

1 Press **INPUT ▲/▼** repeatedly.

■ Operating on the integrated amplifier

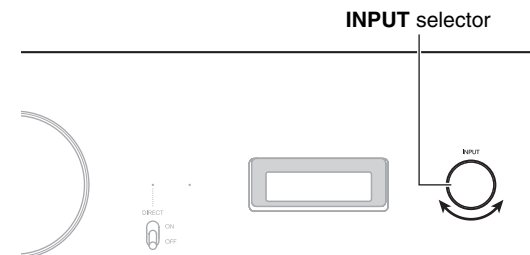

1 Use the **INPUT selector**.

Q Tip

- For changing the input’s name, see “Changing Input Names” (→ [page 36](#)).
- To hide the display of unused inputs, see “Skipping Unused Inputs” (→ [page 37](#)).

Note

- If there is no USB connection, “USB” is not displayed.

Adjusting the Display Brightness

You can adjust the brightness of the integrated amplifier's information display.

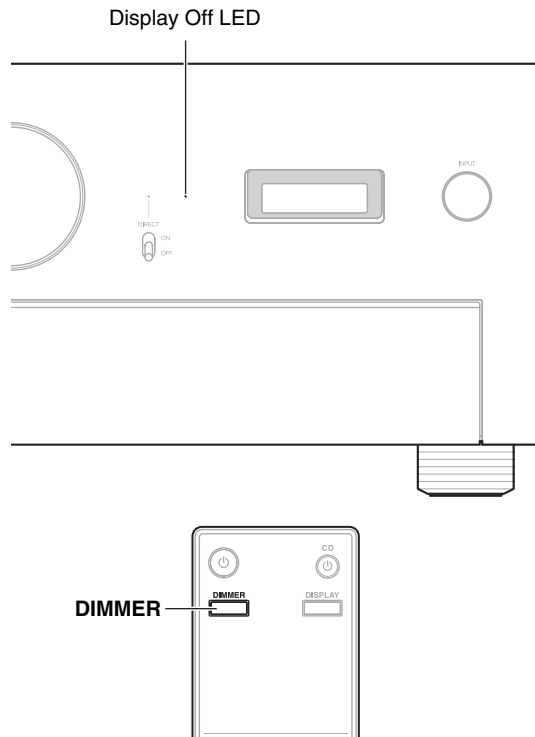

1 Press **DIMMER** repeatedly.

Normal → Dim → Off

Normal

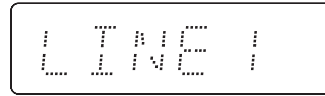

Dim



Off

The Display Off LED lights.



Note

- While the information display is turned off, pressing the buttons used for settings and adjustments on the remote controller or integrated amplifier will briefly activate the display in Dim mode.

Using the Direct Function

By bypassing the tone control circuit, the Direct function uses the shortest path for enhanced sound quality.

Although this function generally turns the display off, the integrated amplifier makes use of a display that doesn't affect the sound quality. It is therefore possible to turn the display on while the Direct function is enabled. Also, since the left/right balance setting uses a system that doesn't affect the sound quality, the balance can be adjusted even if the Direct function is enabled.

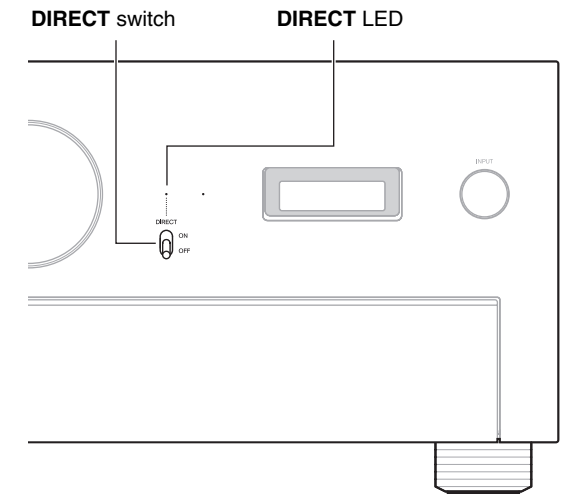

1 Set the **DIRECT** switch to the **ON** position.

The information display goes off and the **DIRECT** LED lights.

Tip

- To turn the information display on while the Direct function is enabled, press **DIMMER** on the remote controller.

Adjusting the Bass, Treble and Balance

You can adjust the bass, treble and left/right output balance respectively.

■ Operating with the remote controller

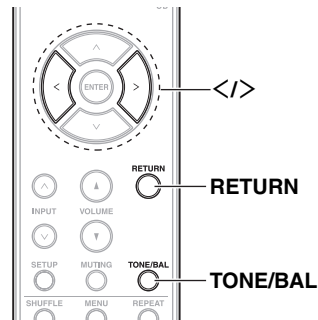

1 Press **TONE/BAL** repeatedly.

▶ **BASS:**

▶ **TRBL (Treble):**

You can adjust the bass and treble levels from -6 to +6.

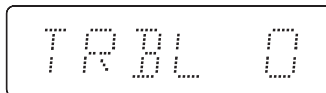
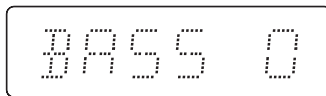

▶ **L, R (Balance):**

The left and right output balance can be adjusted. The more the bars move to the right, the higher the volume will be on the right output. Conversely, the more the bars move to the left, the higher the volume will be on the left output. When no bar appears on the display, the volume is evenly distributed.

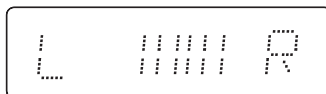

2 Press **</>** repeatedly.

The adjustment is automatically confirmed.
To exit the adjustment, press **RETURN**.

■ Operating on the integrated amplifier

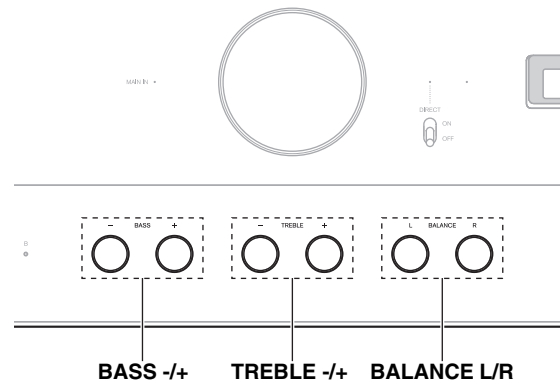

1 Press **BASS -/+, TREBLE -/+, or BALANCE L/R** repeatedly.

The adjustment is automatically confirmed.

Q Tip

- By default, bass and treble are set to 0, and balance is set to the center position (no visible bars).

Note

- The integrated amplifier will end the adjustment if there is no operation for 5 seconds.
- While the Direct function is enabled, the tone controls are disabled and pressing the buttons will display the message "**DIRECT**".
- When headphones are connected, the balance can't be adjusted and pressing the buttons will display the message "**PHONES**".

Muting the Sound

You can temporarily mute the output of the integrated amplifier.

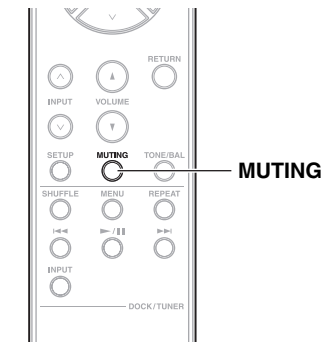

1 Press **MUTING**.

The message "**MUTING**" flashes on the information display.

To unmute the integrated amplifier, press **MUTING** again.

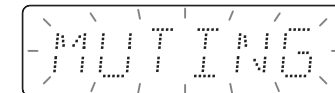

Note

- While the integrated amplifier is muted:
 - Adjusting the volume or setting the integrated amplifier to Standby will unmute the integrated amplifier.
 - Pressing **INPUT** \wedge/\vee on the remote controller or turning the **INPUT** selector on the integrated amplifier will display the current input for 3 seconds.
- If **MUTING** is pressed while a setting is being performed, the setup will be terminated.
- Even if the power is turned off or the power cord is unplugged, the muting function will be maintained on to the next session.

Changing the Display Information

You can display information such as the current input or the value of settings.

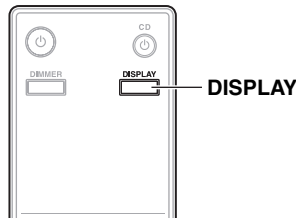

1 Press **DISPLAY** repeatedly.

Current Input

LINE 1

Current Volume

-95 dB

BASS Level

BASS 0

TRBL (Treble) Level

TRBL 0

Input fs (sampling rate)

44.1K

Pre-emphasis Signal Detection

EMPHAS

Setting of ROUTE

NORMAL

To exit the adjustment, press **RETURN**.

Note

- Input fs (sampling rate) is displayed only when a digital input (COAX1, COAX2, OPT, AES-EBU, USB) is selected.
- Depending on the source, the value on the information display may differ from the actual sampling rate's.
- When the Direct function is enabled, "BASS" and "TRBL" are not displayed.
- When a signal treated for treble emphasis (pre-emphasis) is detected, the integrated amplifier is designed to restore the original signal characteristics via the "de-emphasis" process. The message "EMPHAS" only appears when a signal processed with pre-emphasis is detected.
- When "ROUTE" is set to "MAIN", **DISPLAY** can't be used (→ [page 39](#)).

Tip

- When a variation of sampling rate is detected, the value is automatically displayed.

Using Headphones

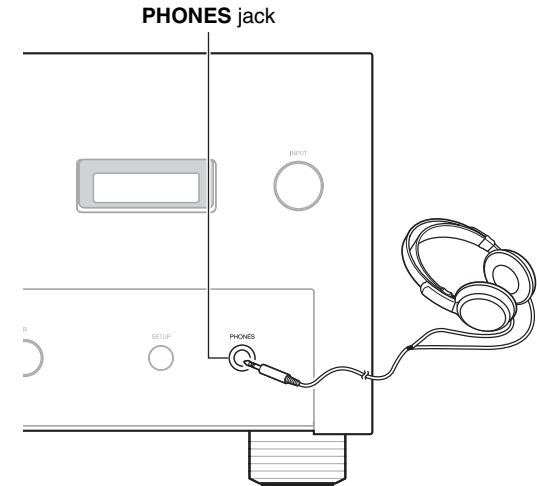

- 1 Connect a pair of stereo headphones with a standard plug (6.3 mm) to the **PHONES** jack. When connecting the headphones, the message "PHONES" appears on the information display and the **A/B** LEDs go off.

PHONES

You can adjust the volume and mute the sound, by using **VOLUME ▲/▼**.

While headphones are connected, no sound is output from the speakers and **PRE OUT** jacks.

Tip

- If there's a volume difference between your speakers and your headphones, you can adjust the offset level (→ [page 37](#)).

Note

- Always turn down the volume before connecting your headphones.
- When headphones are connected, the balance adjustment and **SPEAKERS** are disabled. Pressing the buttons will display the message "PHONES".

Controlling Other Onkyo Components

Controlling the Onkyo CD Player

You can use the integrated amplifier's remote controller to control your Onkyo CD player, pointing the remote controller at the CD player's remote control sensor.

Note

- With some components, the remote controller may not work, or only partially.

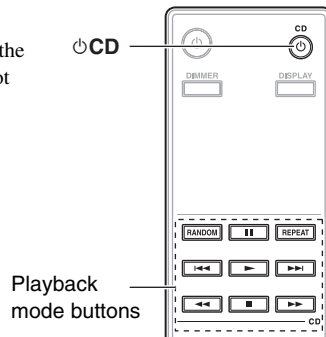

⏻ CD button

Sets the CD Player to On or Standby.

RANDOM button

Performs random playback.

II button

Pauses playback.

REPEAT button

Cycles through the repeat back modes.

⏮ button

Selects the beginning of the current song. Pressing this button twice selects the previous song.

▶ button

Starts playback.

▶▶ button

Selects the next song.

⏪ button

Performs fast reverse playback.

■ button

Stops playback.

▶▶▶ button

Performs fast forward playback.

Controlling the Onkyo Dock

Connect an Onkyo Dock to the integrated amplifier, and play music files from your iPod.

You can use the integrated amplifier's remote controller to control basic iPod functions, but the functionality will depend on your iPod model and generation.

To control the Onkyo Dock, an **FM connection is required (→ page 22).**

To control the Onkyo Dock with the integrated amplifier's remote controller, you need to change the input name to "DOCK" (→ page 36).

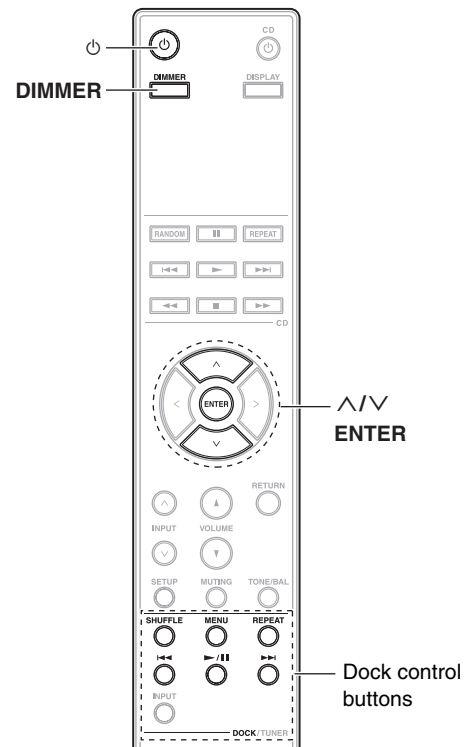

⏻ button

Sets an Onkyo Dock to Standby.

DIMMER button

Adjusts the display brightness.

^/∇ and ENTER buttons

Select a music file.

SHUFFLE button

Performs shuffle playback.

MENU button

Opens iPod menu or returns to the previous menu.

REPEAT button

Cycles through the repeat back modes.

⏮ button

Selects the beginning of the current song. Pressing this button twice selects the previous song.

▶/II button

Starts or pauses playback.

▶▶ button

Selects the next song.

Q Tip

- If you use your iPod with any other accessories, iPod playback detection may not work.
- Use the integrated amplifier's volume control to adjust the playback volume.
- While your iPod is inserted in an Onkyo Dock, its volume control has no effect.

Note

- When the Auto Standby function is activated, the power of the Onkyo Dock connected via **FM** is automatically turned off (→ page 38).

Apple and iPod are trademarks of Apple Inc., registered in the U.S. and other countries.

About Onkyo Dock

Dock is sold separately. Use only the Onkyo Dock with digital connections.

For the latest information on the Onkyo Dock components, see the Onkyo web site at: <http://www.onkyo.com>

Before using the Onkyo Dock components, update your iPod with the latest software, available from the Apple web site.

For supported iPod models, see the instruction manual of the Onkyo Dock.

Controlling the Onkyo Network Tuner

Connect an Onkyo Network Tuner to the integrated amplifier and enjoy its music. You can use the integrated amplifier's remote controller to control the Network Tuner, but the functionality will depend on your Network Tuner's input.

To control the Onkyo Network Tuner, an RI connection is required (→ page 22).

To control the Onkyo Network Tuner with the integrated amplifier's remote controller, you need to change the input name to "TUNER" (→ page 36).

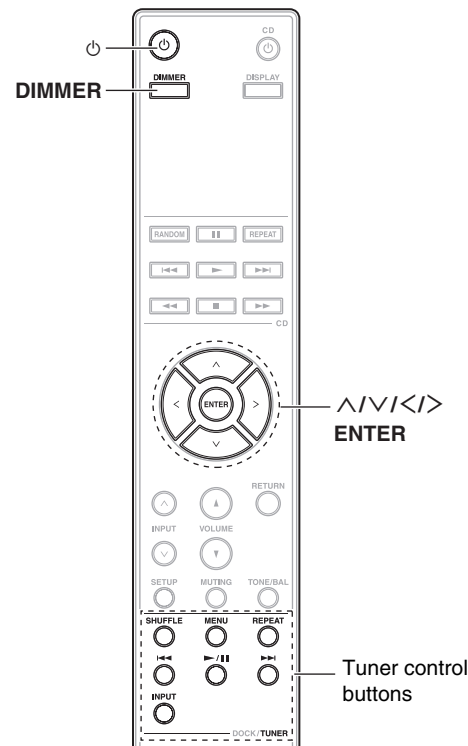

⏻ button

Sets an Onkyo Network Tuner to Standby.

DIMMER button

Adjusts the display brightness.

^/∇/</> and ENTER buttons

Select and adjust settings.

SHUFFLE button

Performs shuffle playback. (When the Network Tuner's input is set to USB or AirPlay.)

MENU button

Returns to the top menu of the Internet Radio service. (When the Network Tuner's input is set to NET.)

REPEAT button

Cycles through the repeat back modes. (When the Network Tuner's input is set to USB or AirPlay.)

⏮ button

Selects the beginning of the current song. Pressing this button twice selects the previous song. (When the Network Tuner's input is set to USB or AirPlay.)

Selects the previous Internet radio station. (When the Network Tuner's input is set to NET.)

Selects the previous radio preset. (When the Network Tuner's input is set to TUNER.)

▶/|| button

Starts or pauses playback. (When the Network Tuner's input is set to USB, NET or AirPlay.)

▶▶ button

Selects the next song. (When the Network Tuner's input is set to USB or AirPlay.)

Selects the next Internet radio station. (When the Network Tuner's input is set to NET.)

Selects the next radio preset. (When the Network Tuner's input is set to TUNER.)

INPUT button

Cycles through the input sources.

Using the Integrated Amplifier as a USB Audio Device

Using the USB port on the rear panel of the A-9000R, you can connect your PC and play back 192 kHz/24-bit HD audio formats.

Connecting a PC

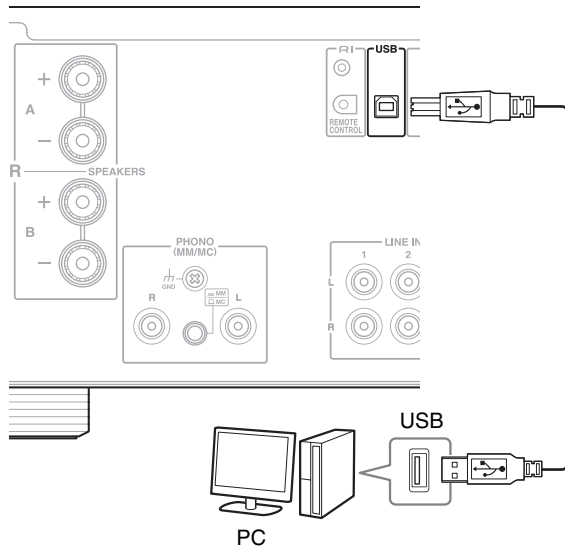

Installing USB drivers

To playback the audio data stored on your PC by using the equipment via USB port connection, you must install the driver on your PC from the following URL:
<http://www.eu.onkyo.com> (for the European customer)
<http://www.intl.onkyo.com/downloads/software/index.html> (for the other area customer)

For the installation procedure, see the above Onkyo Web site.

Playing Music Files from the PC

■ Operating with the remote controller

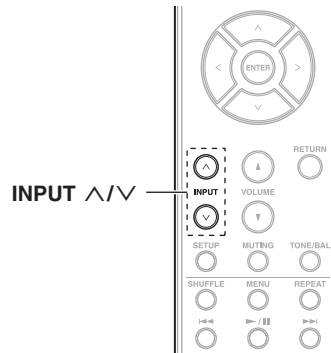

- 1 Press **INPUT** \wedge/∇ repeatedly to switch the input to “USB”.
- 2 Play music files from the PC.

■ Operating on the integrated amplifier

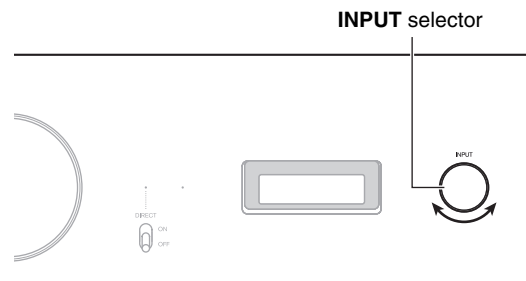

- 1 Use the **INPUT** selector to switch the input to “USB”.
- 2 Play music files from the PC.

📄 Note

- Depending on the audio player software used, the sound of incompatible file formats may not be output.
- If you unplug the USB cable, the message “USB” flashes on the information display.
- If the USB connector of your PC does not support the high-speed 2.0 standard, the audio will not be output.
- If there is no USB connection between the PC and the integrated amplifier, the “USB” input can't be selected.

■ System Requirements (PC)

USB	1
OS	Windows® 7 (32 bits/64 bits)/ Windows Vista® (32/64 bits)/ Windows® XP (32/64 bits) SP3 or later
CPU	Intel® Pentium® 4 processor 1.6 GHz or higher processor
RAM	512 MB or greater
HDD	60 MB or greater free hard drive space
Supported models	PC/AT compatible machine equipped with a USB port compliant with the USB standard Rev2.0 HS (Intel® USB host controller is recommended)

Windows and the Windows logo are trademarks of the Microsoft group of companies.

Custom Setup

You can perform custom settings using **SETUP** on the remote controller or the integrated amplifier. The **SETUP** menu allows you to set the following items: **NAME**, **SHOW**, **HPLVL**, **ASb**, **ROUTE**, and **RESET**.

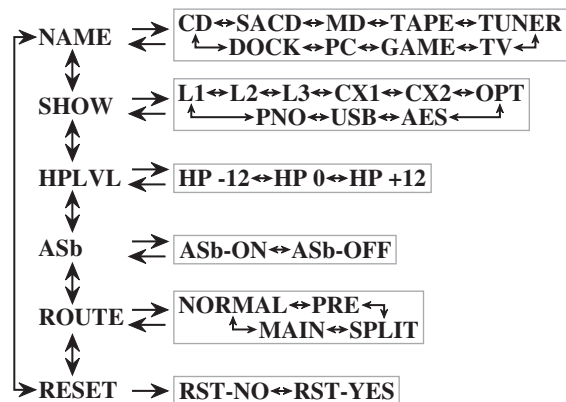

Note

- When “ROUTE” is set to “MAIN”, the “NAME”, “SHOW”, “HPLVL” and “ASb” settings are not available.
- When the “USB” or “PHONO” input is selected, “NAME” setting is not available.

Changing Input Names

You can change the name of the currently selected input. Choose a name from the following: **CD**, **SACD**, **MD**, **TAPE**, **TUNER**, **TV**, **GAME**, **PC**, **DOCK**

■ Operating with the remote controller

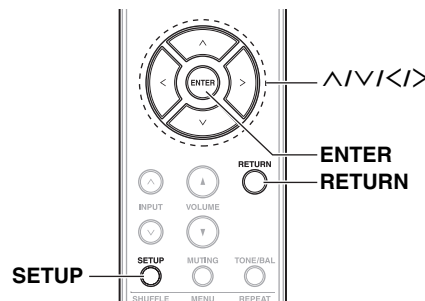

- 1 Press **SETUP**.
- 2 Press **^/∨** repeatedly to select “NAME”.

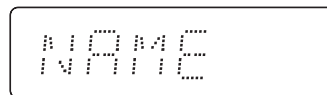

- 3 Press **ENTER**.
The name currently assigned to the input flashes.
- 4 Press **</>** repeatedly to select the name you want to assign.
The selected name flashes.

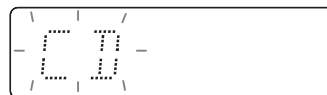

- 5 Press **ENTER**.
The selected name flashes rapidly for a few times as the setting is confirmed.
- 6 Press **RETURN** repeatedly to exit the setup.

■ Operating on the integrated amplifier

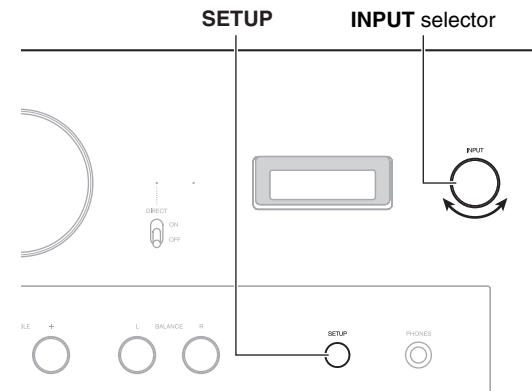

- 1 Press **SETUP** repeatedly to select “NAME”.
- 2 Use the **INPUT selector** to select the name you want to assign.
First, the currently assigned name flashes on the information display. Then, the assignable names are displayed flashing.
- 3 Press and hold down **SETUP**.
The selected name flashes rapidly for a few times as the setting is confirmed.
- 4 Press **SETUP** repeatedly to exit the setup.

Q Tip

- By default, input names are set according to the terminal names.

Note

- If you assign a name that is already used on another input, the name of that other input will be restored to its default.
- When the “USB” or “PHONO” input is selected, “NAME” setting is not available.
- The integrated amplifier will end the setup if there is no operation for 8 seconds.

Skipping Unused Inputs

You can hide the display of those inputs that are not used, so that they are skipped when selecting an input. Change any input from the following: **L1(LINE1)**, **L2(LINE2)**, **L3(LINE3)**, **CX1(COAX1)**, **CX2(COAX2)**, **OPT**, **AES(AES-EBU)**, **USB**, **PNO(PHONO)**

■ Operating with the remote controller

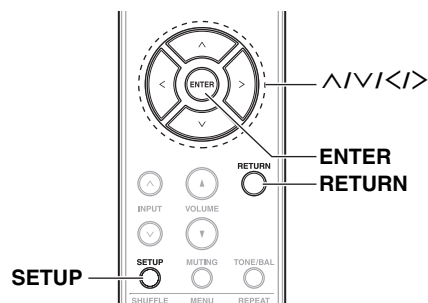

1 Press **SETUP**.

2 Press **^/∇** repeatedly to select “SHOW”.

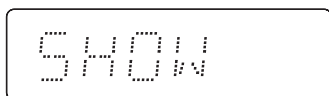

3 Press **ENTER**.

4 Press **^/∇** repeatedly to select the input you want to change.

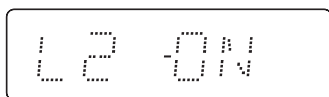

5 Press **⟨/⟩** to switch between **ON** and **OFF**.

▶ **ON:**

Shows the display of selected input.

▶ **OFF:**

Hides the display of selected input.

The setting is automatically confirmed.

6 Press **RETURN** repeatedly to exit the setup.

■ Operating on the integrated amplifier

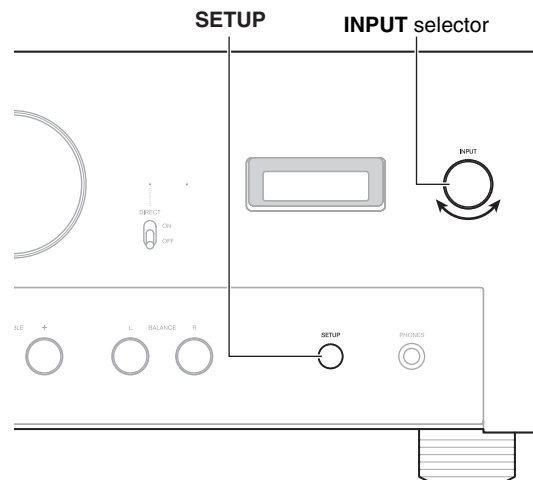

1 Press **SETUP** repeatedly to select “SHOW”.

2 Use the **INPUT** selector to select the input you want to change.

3 Press and hold down **SETUP**.

The setting is switched ON/OFF.

The setting is automatically confirmed.

4 Press **SETUP** repeatedly to exit the setup.

Q Tip

- The default setting is ON.

Note

- The current input doesn't appear as selectable. For example, if the input is currently set to “LINE1”, “L1” won't appear as selectable.
- The integrated amplifier will end the setup if there is no operation for 8 seconds.

Setting the Headphone Level

You can set the volume when using headphones.

■ Operating with the remote controller

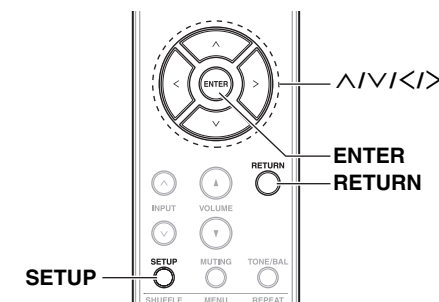

1 Press **SETUP**.

2 Press **^/∇** repeatedly to select “HPLVL”.

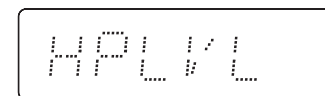

3 Press **ENTER**.

The current level is displayed.

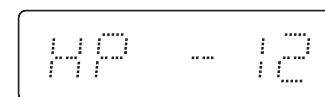

4 Press **⟨/⟩** repeatedly to adjust the offset level.

You can adjust the offset level from -12 dB to +12 dB in 1 dB steps.

The setting is automatically confirmed.

5 Press **RETURN** repeatedly to exit the setup.

Setting the Auto Standby Function

■ Operating on the integrated amplifier

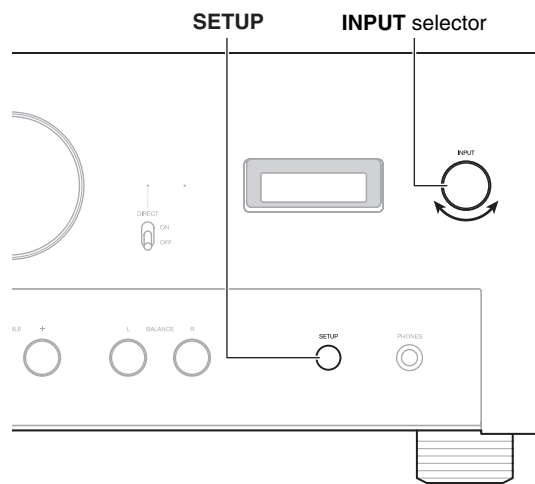

- 1 Press **SETUP** repeatedly to select “HPLVL”.
- 2 Use the **INPUT selector** to adjust the offset level.
First, the current level flashes on the information display. Then, the value is adjusted.
The setting is automatically confirmed.
- 3 Press **SETUP** repeatedly to exit the setup.

Q Tip

- The default level is 0.

Note

- The integrated amplifier will end the setup if there is no operation for 8 seconds.

When the Auto Standby (ASb) function is activated, the integrated amplifier will automatically enter Standby mode if there is no operation for 30 minutes with no audio signal input.

■ Operating with the remote controller

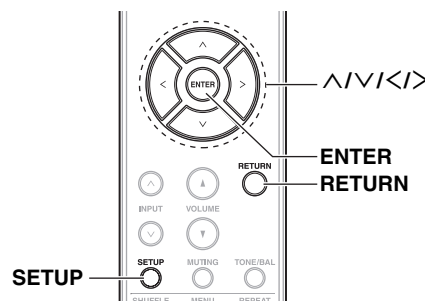

- 1 Press **SETUP**.
- 2 Press **^/∨** repeatedly to select “ASb”.

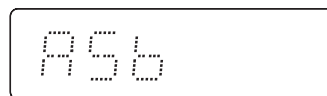

- 3 Press **ENTER**.
The current setting is displayed.

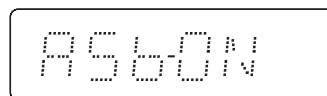

- 4 Press **</>** to switch between “ASb-ON” and “ASb-OFF”.
 - ▶ **ASb-ON:**
Enables Auto Standby.
 - ▶ **ASb-OFF:**
Disables Auto Standby.
 The setting is automatically confirmed.
- 5 Press **RETURN** repeatedly to exit the setup.

Once the Auto Standby (ASb) function has been activated, the integrated amplifier will not automatically turn on

even if it receives a signal. To turn on the integrated amplifier, press **ON/STANDBY** on the integrated amplifier or **⏻** on the remote controller manually.

■ Operating on the integrated amplifier

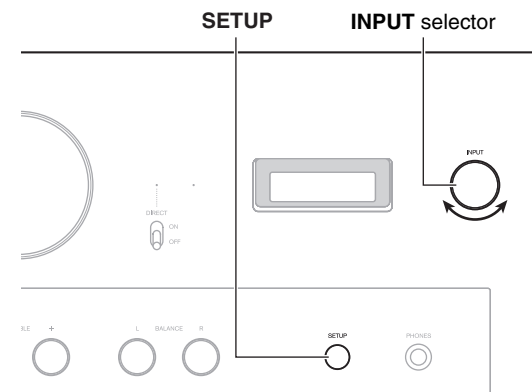

- 1 Press **SETUP** repeatedly to select “ASb”.
- 2 Use the **INPUT selector** to switch between “ASb-ON” and “ASb-OFF”.
First, the current setting flashes on the information display. Then, the setting is switched ON/OFF.
The setting is automatically confirmed.
- 3 Press **SETUP** repeatedly to exit the setup.

Q Tip

- The default setting is ON.

Note

- When the Auto Standby (ASb) function is activated, Onkyo components connected via **RI** are automatically turned off (→ **page 22**).
- Before entering Standby mode with the Auto Standby (ASb) function, the message “ASb” flashes for 30 seconds on the information display.
- The integrated amplifier will end the setup if there is no operation for 8 seconds.

Setting the Route

You can specify the function (Route) of the integrated amplifier by selecting between Normal, Pre, Split, and Main modes.

■ Operating with the remote controller

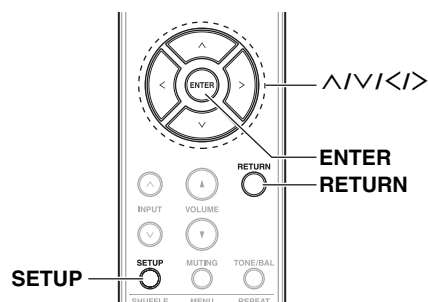

1 Press **SETUP**.

2 Press **^/∨** repeatedly to select “ROUTE”.

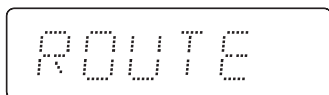

3 Press **ENTER**.

The route currently selected is displayed.

4 Press **⟨/⟩** repeatedly to select the route you want to set.

The selected route flashes.

▶ **NORMAL:**

With this setting, you can use the integrated amplifier as is.

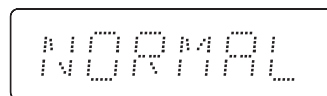

▶ **PRE:**

With this setting, you can use the integrated amplifier as a preamplifier (→ page 25).

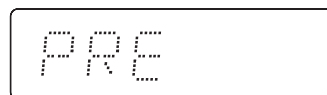

▶ **SPLIT:**

With this setting, you can use the integrated amplifier’s pre-amp and power amp units separately (→ page 26).

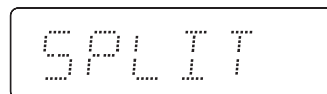

▶ **MAIN:**

With this setting, you can use the integrated amplifier as a power amplifier (→ page 27). When it is selected, the **MAIN IN** LED lights.

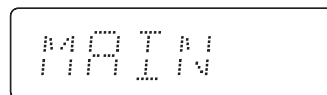

5 Press **ENTER**.

The selected route flashes rapidly for a few times as the setting is confirmed.

6 Press **RETURN** repeatedly to exit the setup.

■ Operating on the integrated amplifier

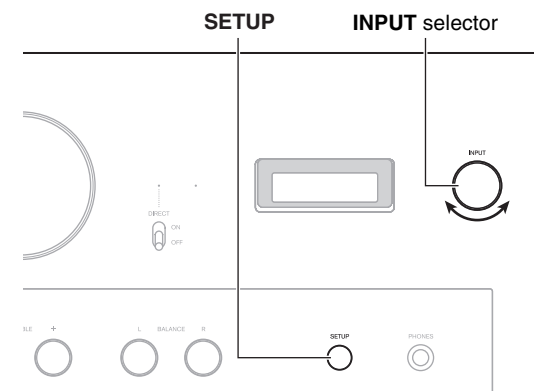

1 Press **SETUP** repeatedly to select “ROUTE”.

2 Use the **INPUT** selector to select the route you want to set.

First, the current setting flashes on the information display. Then, the selectable routes are displayed flashing.

3 Press and hold down **SETUP**.

The selected route flashes rapidly for a few times as the setting is confirmed.

4 Press **SETUP** repeatedly to exit the setup.

Q Tip

- The default setting is “NORMAL”.

📄 Note

- In “PRE” mode, **SPEAKERS** can’t be used.
- In “SPLIT” mode, you need to use **PRE OUT** and **MAIN IN**.
- In “MAIN” mode, only **SPEAKERS** and **SETUP** can be used.
- In “MAIN” mode, the audio coming from **MAIN IN** is output by speakers with a 32.5 dB amplification.
- The integrated amplifier will end the setup if there is no operation for 8 seconds.

Restoring the Default Settings

You can restore the default settings of the integrated amplifier.

■ Operating with the remote controller

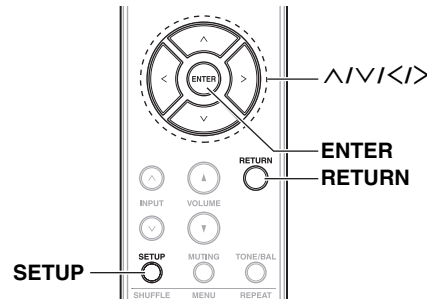

1 Press **SETUP**.

2 Press \wedge/\vee repeatedly to select “RESET”.

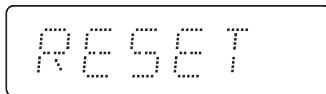

3 Press **ENTER**.

The current setting flashes on the information display.

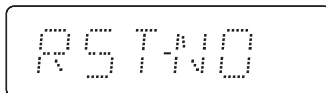

4 Press \langle/\rangle to switch between “RST-NO” and “RST-YES”.

- ▶ **RST-YES:**
Restores the default settings.
- ▶ **RST-NO:**
Cancels the operation.

5 Press **ENTER**.

If “RST-YES” is selected, “CLEAR” appears on the information display. The integrated amplifier then automatically turns off.

If “RST-NO” is selected, the setup returns to “RESET”.

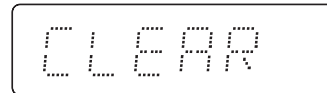

■ Operating on the integrated amplifier

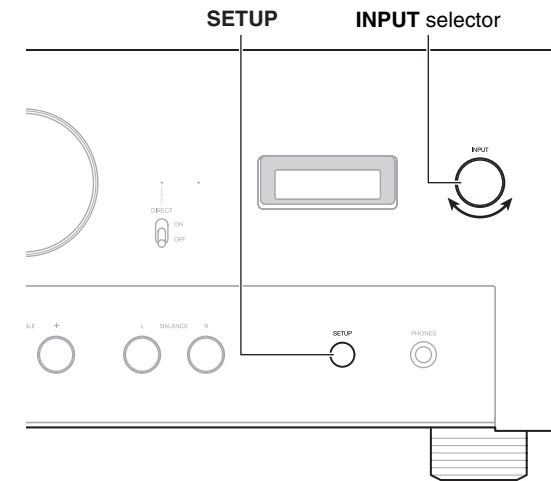

1 Press **SETUP** repeatedly to select “RESET”.

2 Use the **INPUT selector** to switch between “RST-YES” and “RST-NO”.

First, the current setting flashes on the information display. Then, the setting is switched while flashing.

3 Press and hold down **SETUP**.

If “RST-YES” is selected, “CLEAR” appears on the information display. The integrated amplifier then automatically turns off.

If “RST-NO” is selected, the setup returns to “RESET”.

📄 Note

- The integrated amplifier will end the setup if there is no operation for 8 seconds.

Troubleshooting

If you have any trouble using the integrated amplifier, look for a solution in this section.

If you can't resolve the issue yourself, try resetting the integrated amplifier before contacting your Onkyo dealer. To reset the integrated amplifier to its factory defaults, see "Restoring the Default Settings" (→ [page 40](#)).

Power

Can't turn on the Integrated Amplifier.

- Make sure the POWER switch is set to ON.
- Make sure that the power cord is properly plugged into the wall outlet (→ [page 18](#)).
- Unplug the power cord from the wall outlet, wait 5 seconds or more, then plug it in again.

The Integrated Amplifier turns off unexpectedly.

- When the Auto Standby function is activated, the integrated amplifier will automatically enter Standby mode (→ [page 38](#)).
- When the protection circuit is activated (because of speaker short-circuit, overload, or over-current), the integrated amplifier enters Standby mode. Remove the source of the problem and turn the integrated amplifier back on.

Audio

There's no sound.

- Make sure the POWER switch is set to ON.
- Make sure the integrated amplifier's volume control is not set to minimum (→ [page 29](#)).
- Make sure the correct input source is selected (→ [page 29](#)).
- Make sure the integrated amplifier is not muted (→ [page 31](#)).
- Make sure the speakers are connected correctly (→ [page 15](#)).
- Check all connections and correct as necessary (→ [page 15](#)).
- While headphones are connected, the speakers and **PRE OUT** output no sound (→ [page 32](#)).
- The integrated amplifier does not support digital formats other than PCM. Inputting a digital format other than PCM will cause loud noise.
- If the USB connector of your PC does not support the high-speed 2.0 standard, then audio is not output.
- If "ROUTE" is set to anything other than "NORMAL", make sure that each component is connected accordingly (→ [pages 25 to 27, 39](#)).

The sound quality is not good.

- Make sure the speaker cables are connected with the correct polarity (→ [page 15](#)).
- Make sure all audio connecting plugs are pushed in all the way (→ [page 17](#)).
- The sound quality can be affected by strong magnetic fields, such as those from a TV. Try moving any such devices away from the integrated amplifier.
- If you have any devices that emit high-intensity radio waves near the integrated amplifier, such as a cellular phone that's being used to make a call, the integrated amplifier may output noise.

Headphone output is intermittent or there's no sound.

- This may be due to dirty contacts. Clean the headphones plug. See your headphones' instruction manual for cleaning information. Also, make sure that the headphones cable is not broken or damaged.
- Make sure that "ROUTE" is not set to "MAIN" (→ [page 39](#)).

Audio performance

- Audio performance will be at its best about 10 to 30 minutes after the integrated amplifier has been turned on and had time to warm up.
- Using cable ties to bundle audio cables with speaker or power cables may degrade the sound quality, so refrain from doing it.
- Depending on the country, the integrated amplifier may be polarity-sensitive. In this case, plug the power cord in a way that provides the best sound quality.
- Install the integrated amplifier on a sturdy rack or shelf. Position it so that its weight is evenly dispersed on its four legs. Do not install the integrated amplifier in a place with vibration or an unstable location.
- Plug the power cord into an AC wall outlet.

PC Playback

Can't play music files from the PC.

- Make sure that the USB cable is plugged in firmly (→ **page 35**).
- Make sure that the USB driver is installed successfully (→ **page 35**).
- Make sure that there is no unsupported file formats or signals.

The message "USB" flashes on the information display.

- The USB cable is unplugged. Plug the USB cable again.

Onkyo Dock

There's no sound.

- Make sure that the Onkyo Dock is connected to the integrated amplifier properly.
- Make sure that no video content is being played.
- Reset the iPod.

Other

- When the Auto Standby (ASb) function is activated, the power of the Onkyo Dock connected via **RI** is automatically turned off (→ **page 38**).

Can't control properly by using the remote controller.

- Make sure that the **RI** cable is connected to the integrated amplifier correctly.
You need to change the input name to use **RI** function (→ **page 36**).

External Components

No sound is heard from a connected component.

- Make sure the correct input source is selected (→ **page 29**).
- If "ROUTE" is set to anything other than "NORMAL", make sure that each component is connected accordingly (→ **pages 25 to 27, 39**).
- Make sure the analog audio cable is connected correctly (→ **page 17**).

The sound from turntable is distorted.

- If your turntable (MM/MC) has a built-in phono preamp, connect to other analog inputs such as **LINE IN**.
- If your turntable (MM/MC) does not have a built-in phono preamp, connect a turntable to **PHONO** (→ **page 23**).
- Make sure that the ground wire is connected. Otherwise, it may produce an audible hum and noise.
- Make sure the MM/MC selector is set in accordance with the cartridge format of your turntable.

A popping noise is produced when the power is set to on or off.

- Turn each of the components' power on or off in the following order.

When turning the power on:

1. Source component
2. Integrated Amplifier (A-9000R)

When turning the power off:

1. Integrated Amplifier (A-9000R)
2. Source component

Remote Controller

The remote controller doesn't work properly.

- Make sure the batteries have been installed with the correct polarity (+/-) (→ **page 10**).
- Replace both batteries with new ones. (Do not mix different types of batteries or new and old batteries.)
- The remote controller is too far away from the integrated amplifier, or there's an obstacle between them (→ **page 10**).
- The integrated amplifier's remote control sensor is being subjected to bright light (inverter-type fluorescent light or sunlight).
- The integrated amplifier is located behind the glass doors of an audio rack or cabinet.

Onkyo is not responsible for damages (such as CD rental fees) due to unsuccessful recordings caused by the unit's malfunction. Before you record important data, make sure that the material will be recorded correctly.

The integrated amplifier contains a microcomputer for signal processing and control functions. In very rare situations, severe interference, noise from an external source, or static electricity may cause it to lockup. In the unlikely event that this should happen, unplug the power cord, wait at least 5 seconds, and then plug it again.

Before disconnecting the power cord from the wall outlet, set the main power switch to OFF.

If during idling the cover is too hot to touch, then ventilation needs to be improved.

Specifications

Rated Output Power (Stereo):	2 ch × 75 W at 8 ohms, 20 Hz - 20 kHz, 0.05 %, 2 ch driven (IEC) 2 ch × 140 W at 4 ohms, 20 Hz - 20 kHz, 0.05 %, 2 ch driven (IEC)
Dynamic Power* * IEC60268-Short-term maximum output power	450 W (1 Ω) 310 W (2 Ω) 230 W (3 Ω) 180 W (4 Ω) 100 W (8 Ω)
THD+N (Total Harmonic Distortion+Noise)	0.006 % (1 kHz, half power) 0.008 % (20 Hz - 20 kHz, half power)
Damping Factor	130 (1 kHz, 8 Ω)
Input Sensitivity and Impedance (Unbalance)	150 mV/47 kΩ (LINE) 2.25 mV/47 kΩ (PHONO MM) 0.18 mV/100 Ω (PHONO MC)
Rated RCA Output Level and Impedance	1 V/300 Ω (PRE OUT)
Maximum RCA Output Level and Impedance	5 V/300 Ω (PRE OUT)
Phono Overload	70 mV (MM 1 kHz 0.5 %) 5.2 mV (MC 1 kHz 0.5 %)
Frequency Response	10 Hz - 100 kHz/+0 dB, -1 dB 1 W/8 Ω 1 Hz - 250 kHz/+0 dB, -3 dB 1 W/8 Ω
Tone Control Characteristics	±10 dB, 80 Hz (BASS) ±10 dB, 10 kHz (TREBLE)
Signal to Noise Ratio	107 dB (LINE, IHF-A) 60 dB (PHONO MM, IHF-A) 70 dB (PHONO MC, IHF-A)
Speaker Impedance	4 Ω - 16 Ω (Speakers A or B) 8 Ω - 16 Ω (Speakers A + B)
HICC	140 A
Power Supply	AC 230 V, 50 Hz
Power Consumption	300 W
No-sound Power Consumption	120 W
Standby Power Consumption	0.2 W
Dimensions (W × H × D)	435 mm × 175 mm × 435 mm
Weight	18.5 kg

■ Audio Inputs

Digital Inputs

Optical: 1
Coaxial: 2
AES/EBU: 1

Digital Input Format

2ch PCM

Digital Input Sampling Rate

32 kHz/44.1 kHz/48 kHz/88.2 kHz/96 kHz compatible (OPT)
32 kHz/44.1 kHz/48 kHz/88.2 kHz/96 kHz/176.4 kHz/192 kHz compatible (COAX, AES/EBU)
44.1 kHz/48 kHz/96 kHz/192 kHz compatible (USB)

Analog Stereo Inputs

LINE 1, LINE 2, LINE 3, PHONO (MM/MC), MAIN IN

■ Audio Outputs

Analog Outputs

LINE OUT, PRE OUT

Speaker Outputs

4

Phones

1 (6.3 φ)

■ Others

RI

2

PC Interface

USB

Specifications and features are subject to change without notice.

ONKYO

ONKYO SOUND & VISION CORPORATION

2-1, Nisshin-cho, Neyagawa-shi, OSAKA 572-8540, JAPAN

Tel: 072-831-8023 Fax: 072-831-8163

<http://www.onkyo.com/>

ONKYO U.S.A. CORPORATION

18 Park Way, Upper Saddle River, N.J. 07458, U.S.A.

Tel: 800-229-1687, 201-785-2600 Fax: 201-785-2650

<http://www.us.onkyo.com/>

ONKYO EUROPE ELECTRONICS GmbH

Liegnitzerstrasse 6, 82194 Groebenzell, GERMANY

Tel: +49-8142-4401-0 Fax: +49-8142-4401-555

<http://www.eu.onkyo.com/>

ONKYO EUROPE ELECTRONICS GmbH (UK BRANCH)

The Coach House 81A High Street, Marlow, Buckinghamshire, SL7 1AB, UK

Tel: +44-(0)1628-473-350 Fax: +44-(0)1628-401-700

ONKYO CHINA LIMITED

Unit 1033, 10/F, Star House, No 3, Salisbury Road, Tsim Sha Tsui Kowloon, Hong Kong.

Tel: 852-2429-3118 Fax: 852-2428-9039

<http://www.ch.onkyo.com/>

ONKYO CHINA PRC

1301, 555 Tower, No.555 West NanJin Road, Jin an, Shanghai,

China 200041, Tel: 86-21-52131366 Fax: 86-21-52130396

Y1108-1

SN 29400844

(C) Copyright 2011 ONKYO SOUND & VISION CORPORATION Japan. All rights reserved.



* 2 9 4 0 0 8 4 4 *